



HME

®

HOSPITALITY & SPECIALTY
COMMUNICATIONS

NEXEO | HDX™

Crew Communication Platform

Installation Guide

HM ELECTRONICS, INC.

2848 Whiptail Loop, Carlsbad, CA 92010 USA

Phone: 1-800-848-4468 Fax: 858-552-0172

Website: www.hme.com Email: support@hme.com

HME# PUB-00084

Rev L 1/2/25

REGULATORY AND SAFETY

FCC CERTIFICATION AND MORE:

Regulatory and Compliance information can be found online by going to Drive-Thru Headset Systems>NEXEO | HDX at: <https://www.hme.com/qsr/drive-thru-user-manuals/>

ESD HANDLING INSTRUCTIONS



CAUTION: Contains parts and assemblies susceptible to damage by Electrostatic Discharge (ESD). This device is sensitive to electrostatic discharge and should be installed by personnel trained in ESD awareness. Proper handling procedures include wearing anti-static wrist straps.

SAFETY NOTICE



CAUTION: Wear proper eye, ear, and body protection when grinding, drilling or working with tools. Follow the manufacturer's safety information and operational instructions for tools and materials. Be aware of your surroundings. Failure to heed such precautions can cause injury and/or property damage.

HYGIENE, HEALTH, AND SAFETY

Part of this installation requires working within a restaurant/store where food is prepared and customers dine. Please consult the restaurant/store manager, standard operating procedures and any additional restaurant safety/advisory protocols available before beginning work within the restaurant/store. Follow the instructions and guidelines provided.

BATTERY DISPOSAL



HME cares about the environment. Please consult the laws and regulations within your municipality regarding the proper disposal of expired or dead batteries.

DISCLAIMER

HM Electronics, Inc. is not responsible for equipment malfunctions due to erroneous translation of its publications from their original English version. Illustrations in this publication are approximate representations of the actual equipment, and may not be exactly as the equipment appears. They are subject to change without notice.

TABLE OF CONTENTS

REGULATORY AND SAFETY	III
FCC Certification and More:.....	iii
ESD Handling Instructions.....	iii
Safety Notice	iii
Hygiene, Health, and Safety	iii
Battery Disposal	iii
Disclaimer	iii
WHAT'S IN THE BOX	1
TOOLS/EQUIPMENT/MATERIAL REQUIRED.....	2
INSTALLATION OVERVIEW	3
Wiring connections (Not all connections are required)	4
INSTALLATION	6
Before you begin	6
The Base Station and Connections	6
Installing the System	6
Examples of RT7000 Mounting Locations.....	9
Wiring Diagram for connecting with the IB7000 (DM5 & SS7000 or SP10)	10
INSTALLATION WIZARD OVERVIEW	11
Stage 1: Welcome	11
Stage 2: Connect.....	11
Stage 3: Configure.....	13
COMPONENT NOTES	14
Cable Pulling	14
Remote Transceiver (RT7000).....	14
The Smart Battery Charger (AC70)	16
Headset (HS7000)	18
Voice Commands	19
Setup and Operation	19
SPEAKER POSTS AND ENCLOSURES	20
Dedicated PVC Conduit Requirements	20
Speaker Post/Menu Board Size Requirements	20
INSTALLING THE IB7000.....	21
Installing the weather cover	22
INSTALLING THE MICROPHONE AND SPEAKER	23
The DM5 Microphone.....	23
The SS7000 Speaker (Standard, if not using the SP10).....	24
The SP10 Speaker (Optional, if not using the SS7000)	25
INSTALLING THE TI7000 TELEPHONE INTERFACE (OPTIONAL).....	26
AOT (AUTOMATED ORDER TAKING)	28
NITRO ALERTS	29
HELP	30
Troubleshooting	30
AOT Troubleshooting	31
Troubleshooting Screens	33
Additional Troubleshooting	38
Firmware Updates.....	39
Glossary of terms	40
AOT Glossary of terms.....	41
SPECIFICATIONS.....	42

WHAT'S IN THE BOX

1. Base Station (BS7000) with power adapter
2. Headset (HS7000) and battery (BAT70)
3. Radio Transceiver (RT7000)
4. Battery Charger (AC70) with power adapter
5. IB7000 with DM5 Mic and SS7000 Speaker or SP10 (only speaker is shown)
6. Installation & User's Guide
7. Hardware and cables (not shown)
8. Acoustic Foam (not shown)

The system contents in the box will vary depending on the customer's order. Quantities of certain components such as headsets and batteries will also vary. However, the components listed here consist of the basic components that are generally included with a complete NEXEO® system.

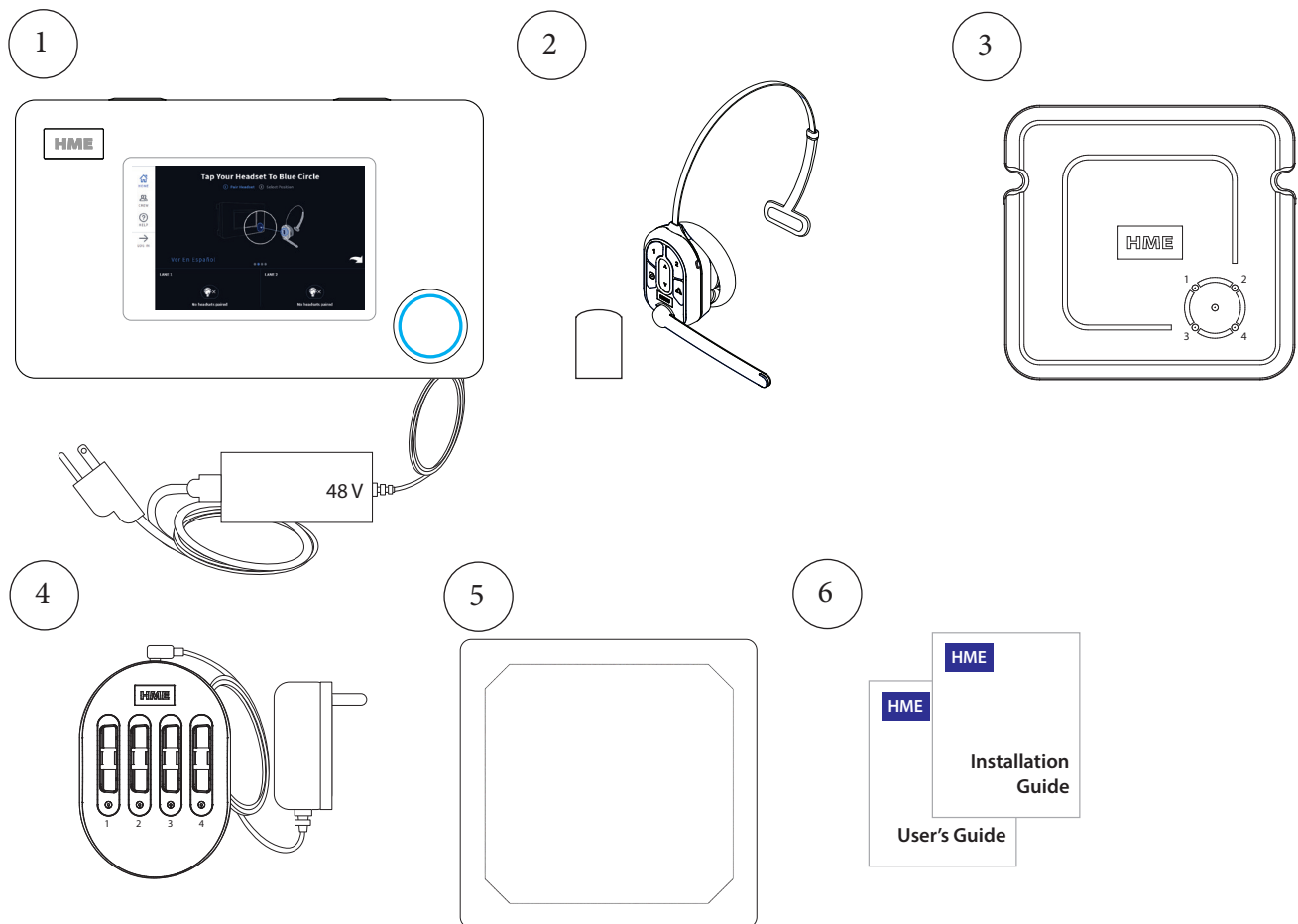

TOOLS/EQUIPMENT/MATERIAL REQUIRED

General Tools/Equipment

- General hand tools, screwdrivers, cutters, pliers, and wrenches
- Standard Drill (for wall mounts)
- Drill bit set (sizes 1/16" - 1/2")
- Wire strippers
- Soldering Iron and solder
- Tape measure
- Pencil/marker
- Crimp caps or shrink tubing with heat gun
- Serrated knife
- Cable pulling equipment: fish stick/tape, pull strings, etc.
- Ladder

Specialty Tools/Equipment

- N/A

Materials

- Cable ties (for bundling any cable slack, available at most hardware/home improvement stores).
- Hardware (while general hardware is provided for mounting system components, there may be situations when specialty hardware is required such as masonry screws for brick or concrete walls).
- Electrical tape, twist caps
- Audio cable
- Acoustic Foam
- Specialty hardware (if required beyond what is included)

Safety Equipment

- Safety Glasses
- ESD grounding strap (recommended when connecting to the PCBA in the Base Station)

INSTALLATION OVERVIEW (TURN 90° CLOCKWISE TO VIEW)

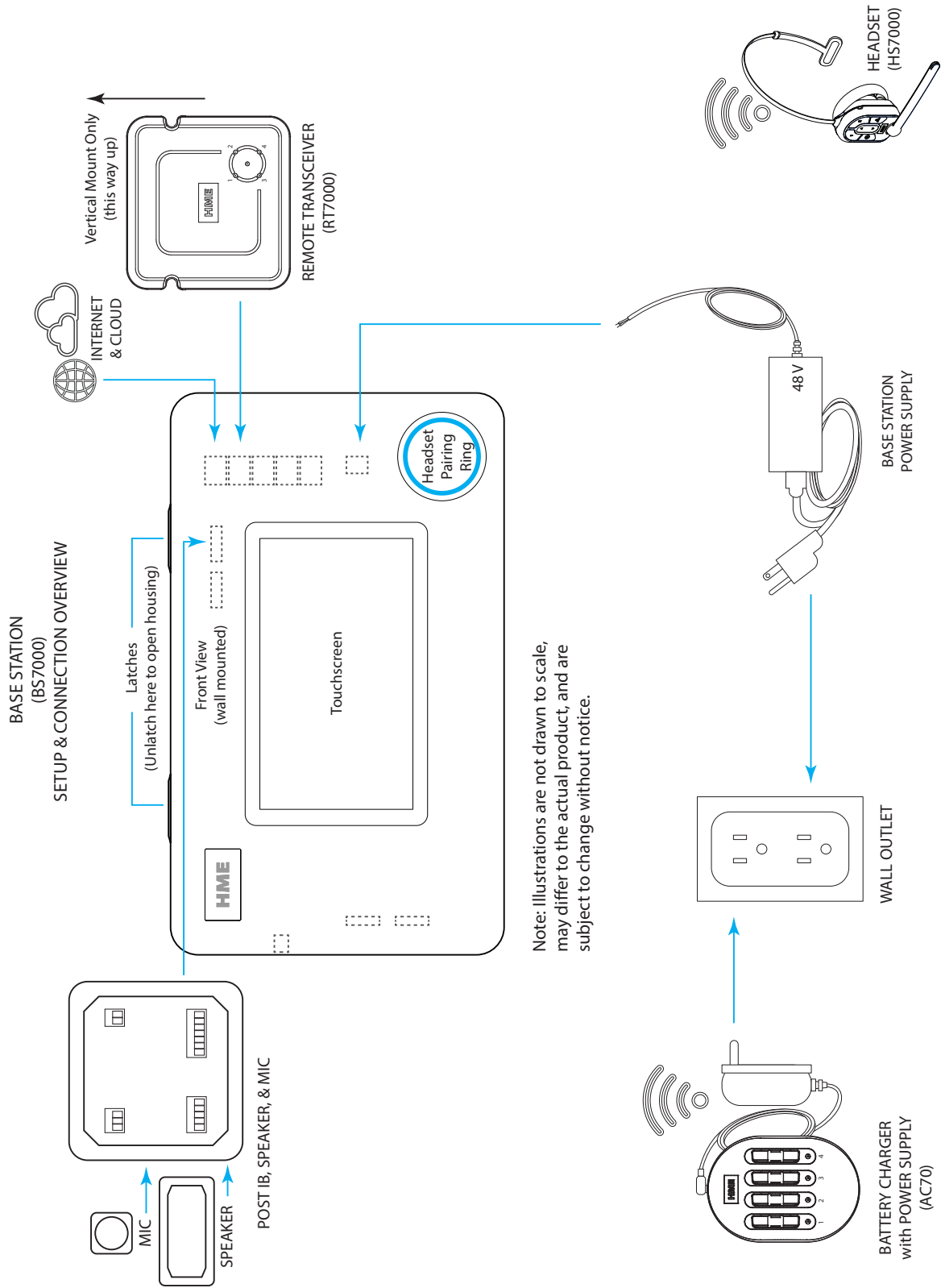

Fig. 1.1

WIRING CONNECTIONS (NOT ALL CONNECTIONS ARE REQUIRED)

J600 (Ceiling Speakers)		
Pin #	Label	Descrptn/wire color
1	Ceiling Spkr1 +	Speaker 1 positive
2	Ceiling Spkr1 -	Speaker 1 negative
3	GND	Ground
4	Ceiling Spkr2 +	Speaker 2 positive
5	Ceiling Spkr2 -	Speaker 2 negative
6	GND	Ground

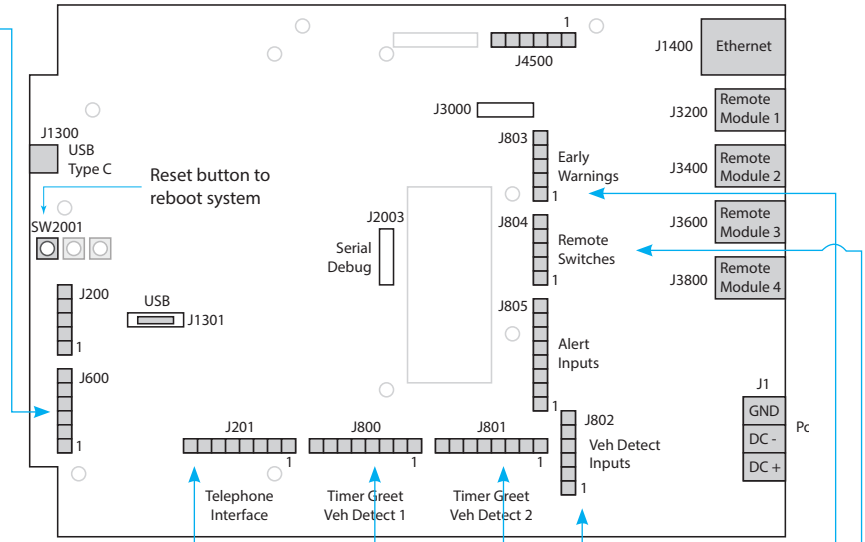

Fig. 1.2

J201 (Telephone Interface)		
Pin #	Label	Description/wire color
1	Tel Audio In	
2	Tel Power +12V	
3	Tel Off Hook	
4	Tel PTT	
5	Tel Ring	
6	Tel Active	
7	Tel Ground	
8	Tel Audio Out	

J800 and J801 (Lane 1 & 2 Timer)		
Pin #	Label	Description/wire color
1	Greet Out (Analog)	Greet Out 1 for J800 Greet Out 2 for J801
2	GND	Ground for J800 and J801
3	N/C	Not connected
4	Alt Grt Out (Digital)	Alt Greet Out 1 for J800 Alt Greet Out 2 for J801
5	GND	Ground for J800 and J801
6	Veh Det Out Com	Veh Det Out Com1 for J800 Veh Det Out Com2 for J801
7	Veh Det Out N.O.	Veh Det Out N.O.1 for J800 Veh Det Out N.O.2 for J801
8	Veh Det Out N.C.	Veh Det Out N.C.1 for J800 Veh Det Out N.C.2 for J801

J802 (Vehicle Detect Inputs)		
Pin #	Label	Description/wire color
1	+12 V	Power
2	N/C	Not connected
3	Veh Det In 1	Vehicle Detect In 1
4	GND	Ground
5	Veh Det In 2	Vehicle Detect In 2
6	GND	Ground

J803 (Early Warning Inputs)		
Pin #	Label	Description/wire color
1	Erly Wrn In 1	Early Warn In 1
2	GND	Ground
3	N/C	Not connected
4	Erly Wrn In 2	Early Warn In 2
5	GND	Ground

J804 (Remote Switch Inputs)		
Pin #	Label	Description/wire color
1	GND	Ground
2	OO in 1	Outside Order in 1
3	Ded in	Dedicated In
4	OO in 2	Outside Order in 2
5	GND	Ground

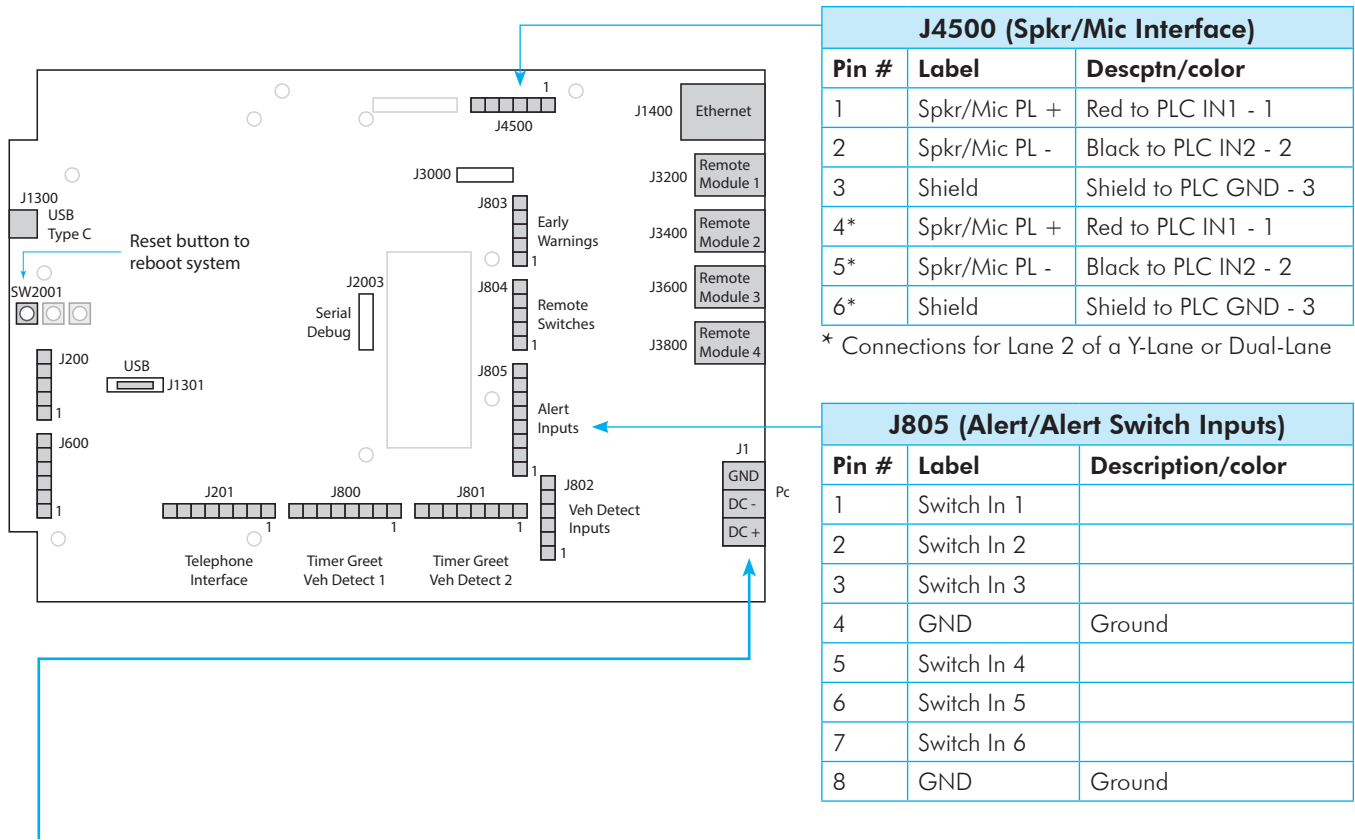

Base Station Power Supply:

1. Terminate the positive wire of the power supply to J1 DC + terminal (pin 1).
2. Terminate the negative wire of the power supply to J1 DC - terminal (pin 2).
3. Terminate the shield to J1 GND terminal (pin 3).

Note: Only use the HME power supply provided with your system.

INSTALLATION

BEFORE YOU BEGIN

Survey the premises with store manager to determine the optimal mounting locations for each component. Take into consideration:

- The system requires a region code to function, so an internet connection and an HME CLOUD account are necessary. Connect and verify first before installing the RT7000.
- Cable lengths for the hardwired components such as the remote transceiver, network connections, etc., which may limit the possible locations available.
- Proximity to power outlet and network router.
- If mounting the Base Station in an area with high foot traffic, take into consideration carts and mobile shelving units, which can damage the Base Station if impacted.
- Finding a good location for the remote transceiver is critical (see Fig. 2.10, and 2.11). Also read about the “Remote Transceiver (RT7000)” on page 14 under Component Notes and review the Critical Steps in these following instructions.

THE BASE STATION AND CONNECTIONS

The Base Station is the control center and focal point of the NEXEO | HDX™ system. System features are configured here and all connections are terminated here. This is also where store personnel interact with the system when setting up profiles and pairing headsets. If you are replacing an existing HME product such as an EOS|HD® system, you may be tempted to use the existing wires/cables without having to route new wires. However, the customer has purchased a new system which includes new cables. **Please discard the old cables and route new cables.**



CAUTION: Wear proper eye, ear, and body protection when grinding or drilling. Be familiar with the manufacturer’s safety information and operational instructions for tools and materials. Be aware of your surroundings. Failure to heed such precautions can cause injury and/or property damage. Before drilling, also make sure the area behind the wall is free from electrical wiring and plumbing.

INSTALLING THE SYSTEM

1. The base station should be mounted in a location easily accessible by all crew members at all times (i.e., not in a locked office with limited access).
2. Mount the Base Station at an optimal height from the floor with the touchscreen visible and within easy reach to comfortably operate with fingers. The recommended mounting height is 5 feet (1.52 m), see Fig. 2.1.

Note: Mounting height should also take into consideration personnel with disabilities, such as those requiring the use of a wheelchair.

3. There are two latches along the top side of the Base Station (see Fig. 2.2). Unlatch these to open the Base Station cover (the cover does not completely detach as it is hinged on the bottom side). Four mounting holes are visible, one at each corner through

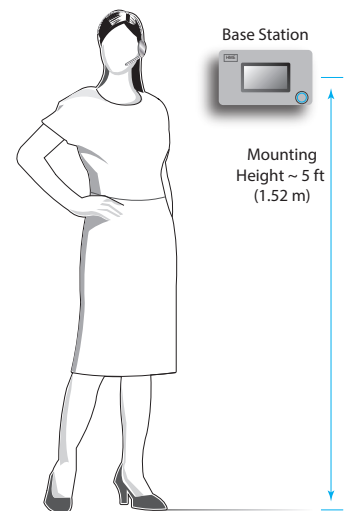



Fig. 2.1

the legs (see Fig. 2.3). Use a pencil to mark the wall through these holes (avoid touching the exposed PCBA unless you are wearing a ground strap). Drill four pilot holes (3/16" drill bit). Push the four plastic anchors into the holes until flush and insert the four screws provided, but do not tighten. Leave enough space to mount the Base Station over the head of the screws and slide into the slots. Tighten screws to secure the Base Station.

4. Mount the power supply. Mark the mounting location on the wall through the mounting holes on each side. Mount the power supply using the hardware provided. Terminate the power supply to the Base Station (see "Wiring Diagram's" Fig. 2.10, 2.11 and wiring connections on page 5).
5. **Critical Step:** Loosely mount and connect the RT7000 (Fig. 2.4 & 2.5) in a central location for optimal coverage (until range tested in steps 9 & 10 with the Installation Wizard). For example, notice Fig. 2.10 and 2.11. They show two different store layouts with specific targeted areas where the headsets are primarily used. In these examples, the location selected for the RT7000 (represented by the small blue rectangle) offered the best coverage indicated by the blue circled areas. Each store required the RT7000 to be mounted in a different but central location to provide the best all-around coverage unique to the store's need. Store layout and obstructions also affected placement and range. (see "Component Notes" on page 14 for more details on the RT7000 placement).



CAUTION: If the RT7000 needs to be relocated, wait at least 5 seconds after unplugging it before re-connecting the cable to the same base station port. This allows time for the system to turn off power to the port, connecting to a live port can damage the circuitry. Or, reconnect it to a different port.

6. Install the other components. The DM5 microphone and SS7000 speaker, or SP10 speaker, must be installed using the IB7000 interface box. Use Fig. 2.12 as a wiring reference and see "Component Notes." for more installation details.
7. Route and terminate all component cables to the Base Station using the wiring references in this guide. Consult the store's IT personnel when connecting to the network router.
8. Terminate the Base Station power supply and connect to outlet. The Base Station turns on automatically and will perform a self-check to determine that all is good and ready to go.
9. On the Base Station UI, follow the Installation Wizard to connect and configure the system (see Fig. 2.6).

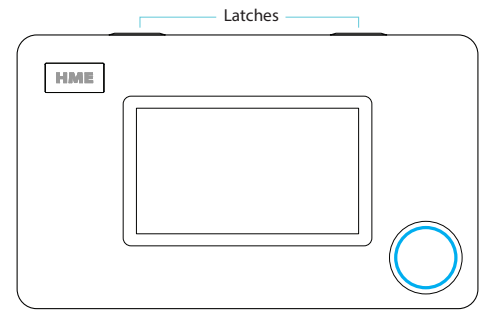

Fig. 2.2

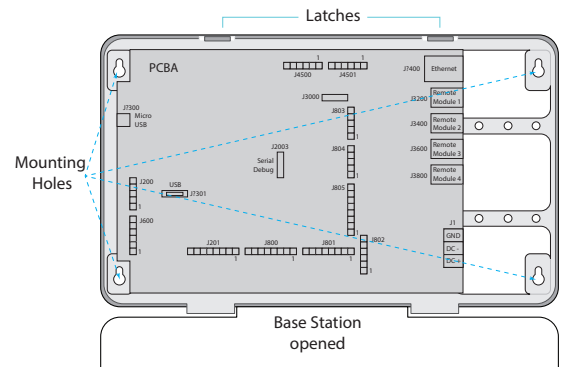

Fig. 2.3

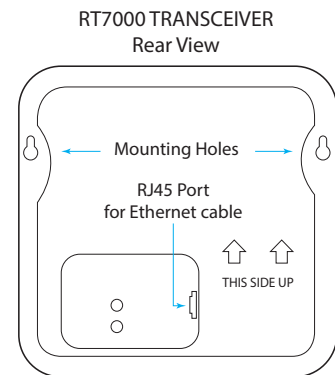

Fig. 2.4

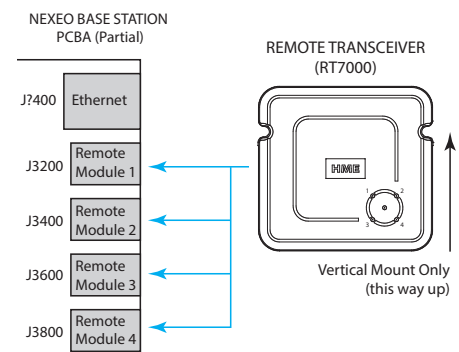

Fig. 2.5

Note: If you accidentally exit the Installation Wizard and need to return to it. LOG IN to the Base Station, go to SYSTEM, then the TROUBLE-SHOOTING tab and select "Installation Wizard" from the drop-down menu. Tap the "Start Installation Wizard" button.

- Critical Step:** At the Configure stage of the Installation Wizard, the Transceiver Installation Step 2 screen prompts you to use a paired headset switched into Reception Location Mode (Fig. 2.7). When you pair a headset at this step, the Reception Location Mode indicator turns from ● OFF to ● ON (Fig. 2.8). Tap "Continue" to move to Transceiver Installation Step 3. You will need to walk all areas of the store where the headset will be used to ensure a good signal. The Boom LED at the tip of the Headset microphone flashes different colors to indicate areas with strong or weak reception (The NEXEO screen displays this color-coded range which is also shown here in Fig. 2.9). Depending on the results, you may have to reposition the Remote Transceiver before finding the optimal location.

Note: Depending on the size and layout of the store, some stores may require more than one Remote Transceiver to provide adequate coverage. Also see CAUTION note for Step 5.

- Once the optimal location for the Remote Transceiver has been verified. Secure all the loosely mounted system components.
- Test audio levels between the headsets and the drive-thru ordering points, adjust accordingly using the volume controls on the Base Station UI.
- Use cable ties to bundle and strain relief the cables exiting the Base Station to one of the cross-bars on the rear housing.
- Close the Base Station. The system is now ready for use.

Note: See "Component Notes" on page 14 for more details on system components. System "Setup And operation" on page 19 and the installation of individual components is also covered beyond this point if additional details are required. If you are alerted concerning a fault or failure, verify the system is configured properly through the Installation Wizard found under SYSTEM>TROUBLE-SHOOTING. Also, reference "Help" on page 30 of this guide.

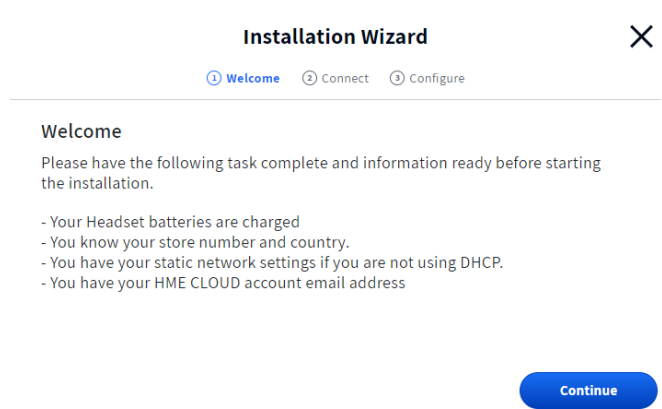

Fig. 2.6

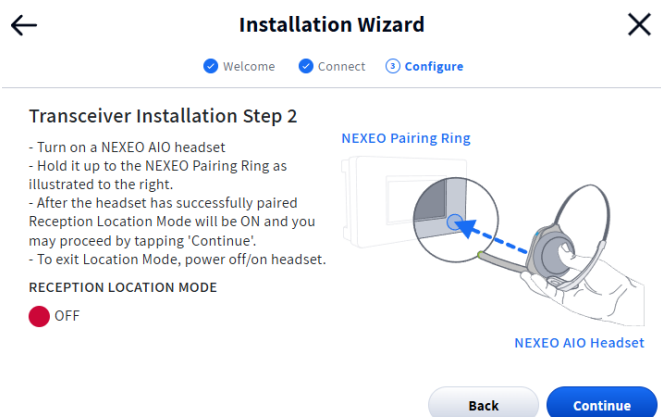

Fig. 2.7



Fig. 2.8

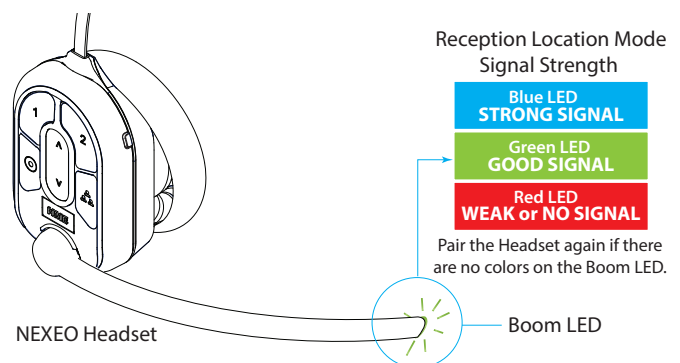

Fig. 2.9

EXAMPLES OF RT7000 MOUNTING LOCATIONS

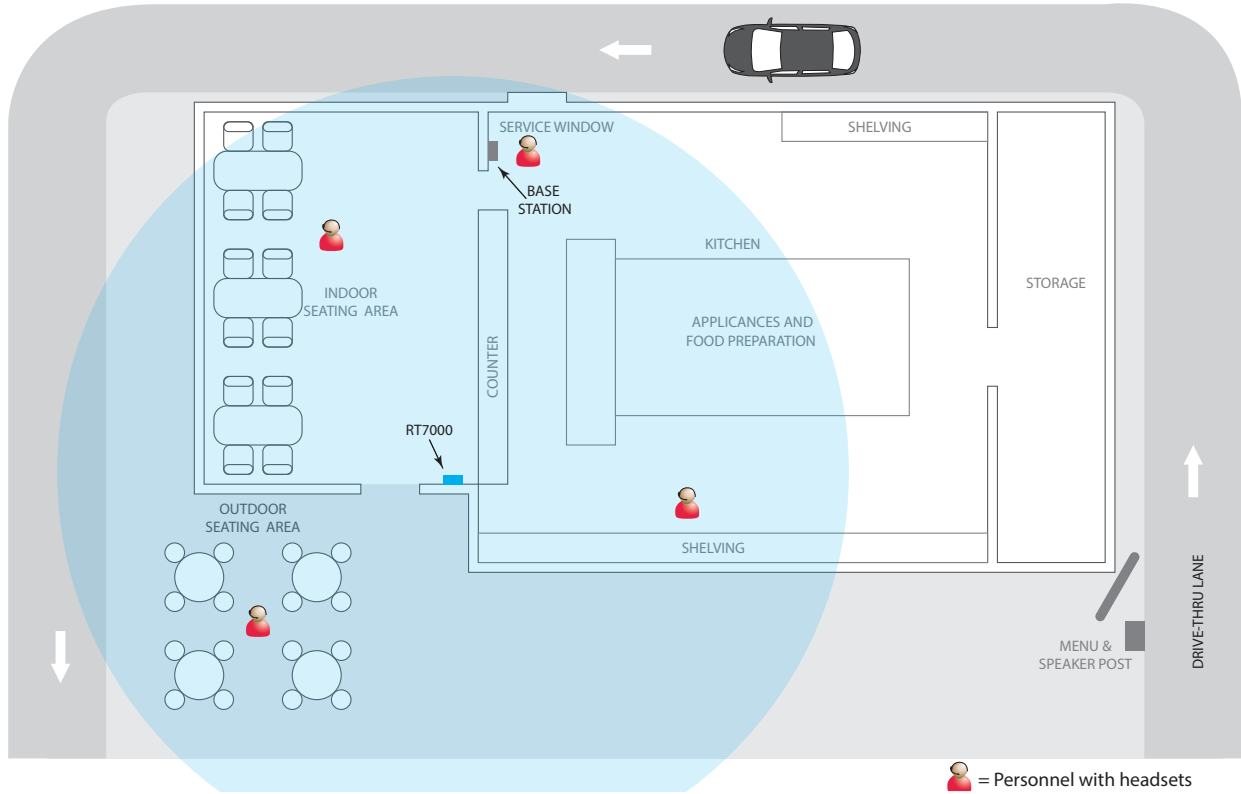

Fig. 2.10

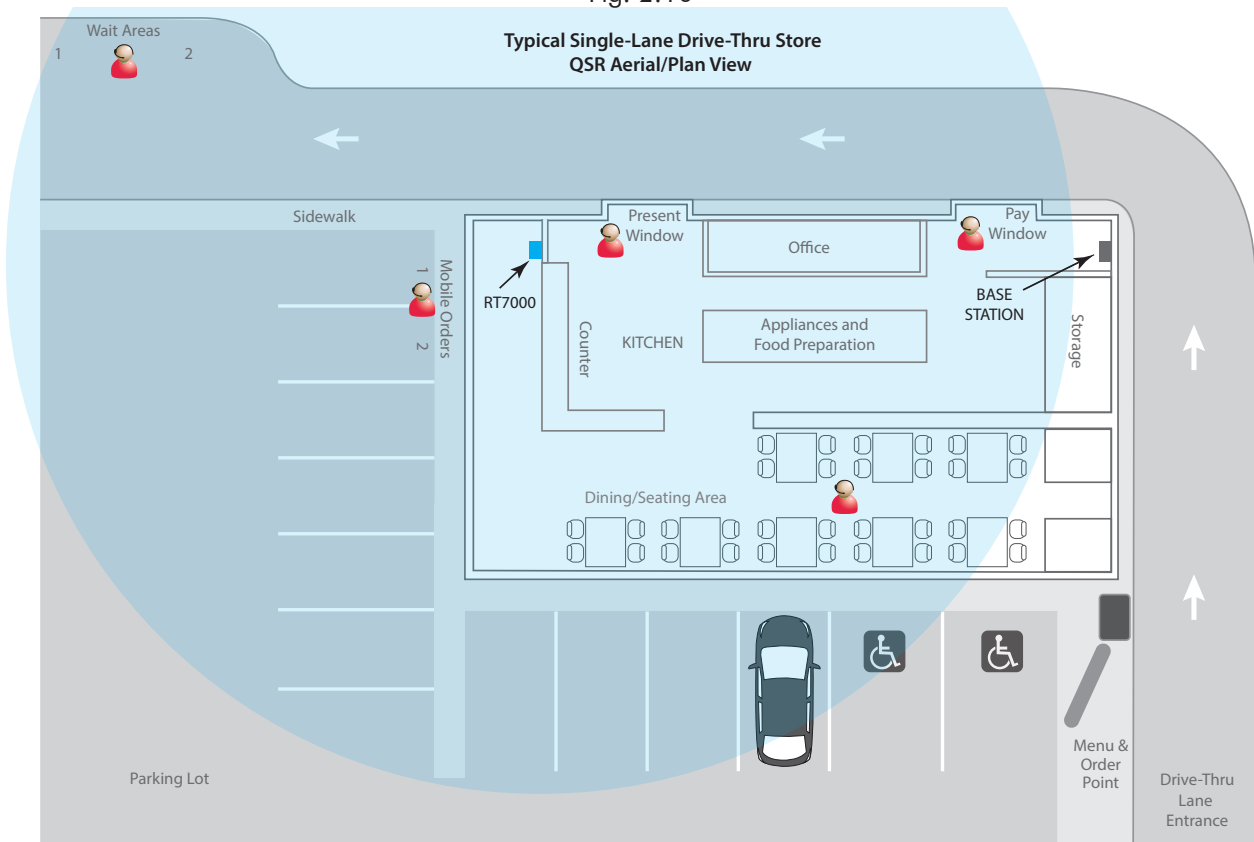

Fig. 2.11

WIRING DIAGRAM FOR CONNECTING WITH THE IB7000 (DM5 & SS7000 OR SP10)

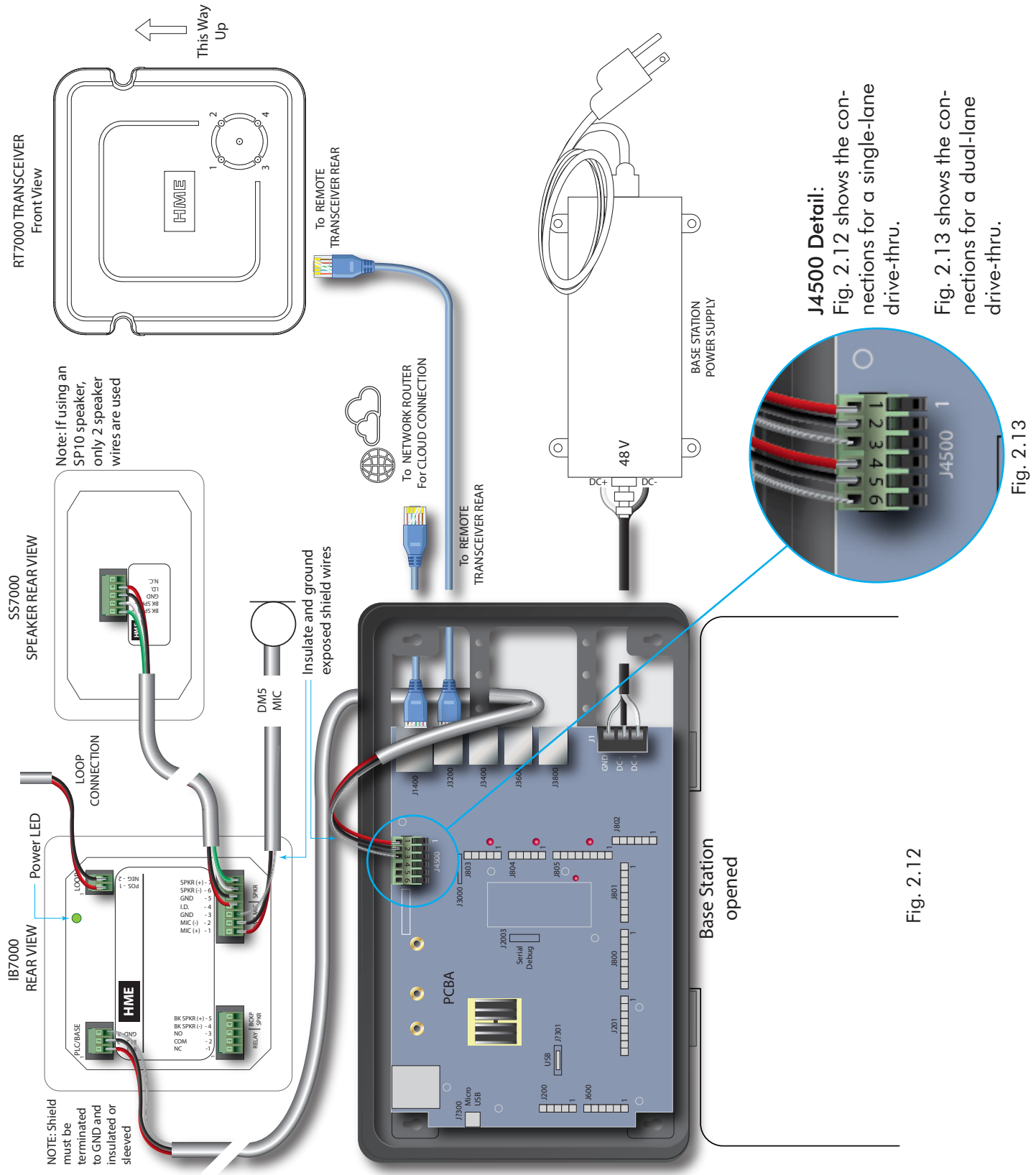



Fig. 2.12

INSTALLATION WIZARD OVERVIEW

Once the system is installed and connected, the Base Station turns on automatically when plugged into an electrical outlet. The Installation Wizard is the first screen you'll encounter if the Base Station is new and not yet configured. You will need your installer's password to access the Installation Wizard. The following information gives you an overview of the Installation Wizard but does not show every screenshot or step involved in completing the installation. The Installation Wizard will guide you through this process.

There are three main setup stages: Welcome, Connect, and Configure. Each stage has several associated steps (screens), and are completed in sequence to advance to the next step unless you have the option to "Skip." Completed stages are indicated by a checkmark (e.g.,  Welcome in Fig. 3.2). The current stage you are in is indicated in blue (e.g.,  Welcome in Fig. 3.1), while stages yet to be completed are in gray.

STAGE 1: WELCOME

After initiating the Installation Wizard, this screen, prompts you as to what is needed before continuing.

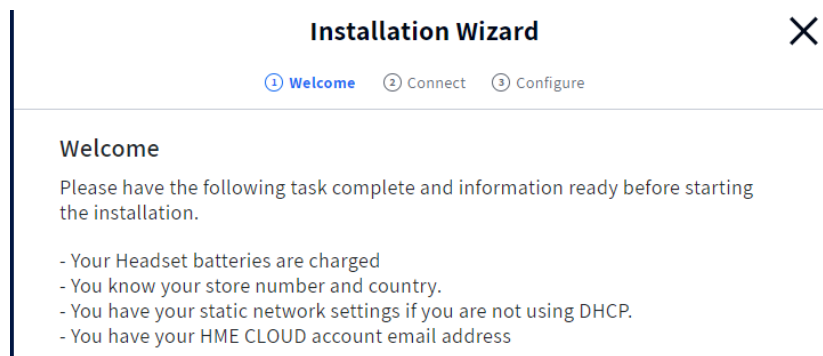



Fig. 3.1

Click the  button to proceed. This next screen provides you with an overview of the stages involved. You have a choice of Manual Setup or Use Wizard. We recommend you use the Wizard.

STAGE 2: CONNECT

This stage connects the system. First, add Store Details and continue to next page. Connect To Network and HME CLOUD. DHCP allows a network administrator to supervise and distribute IP addresses from a central point. When the DHCP is enabled, the system automatically populates the required fields. Consult the Glossary definitions.

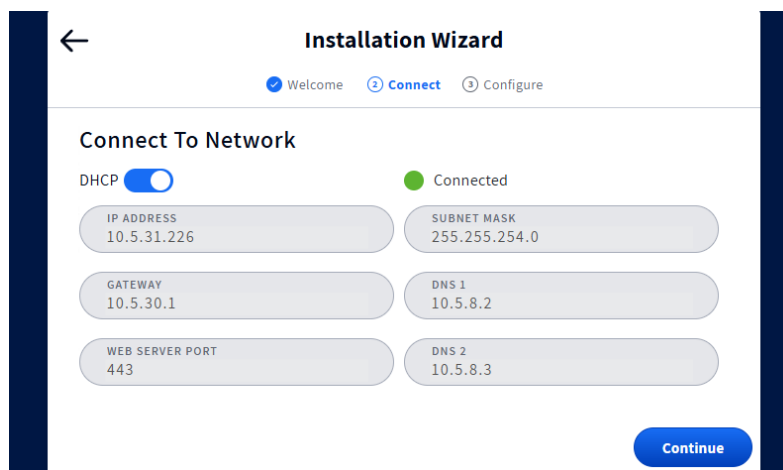

Fig. 3.2

This part of the Installation Wizard also requests you to enter a "Registration Key." The registration key can be found on the Sales Order and allows the customer to link their NEXEO System to the Store. The registration key is then used to register the device. This can be done here through the Installation Wizard or on the HME CLOUD screen after the Installation Wizard is complete (Fig. 3.4). Verify that the registration key matches the store info (Fig. 3.5).

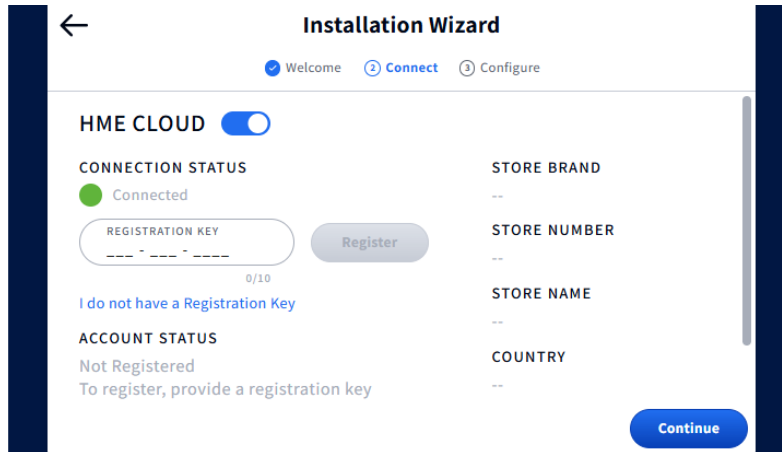

Fig. 3.3

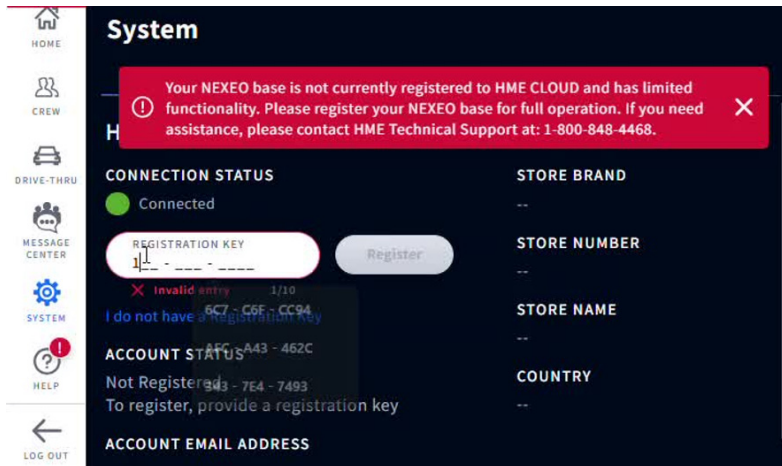

Fig. 3.4

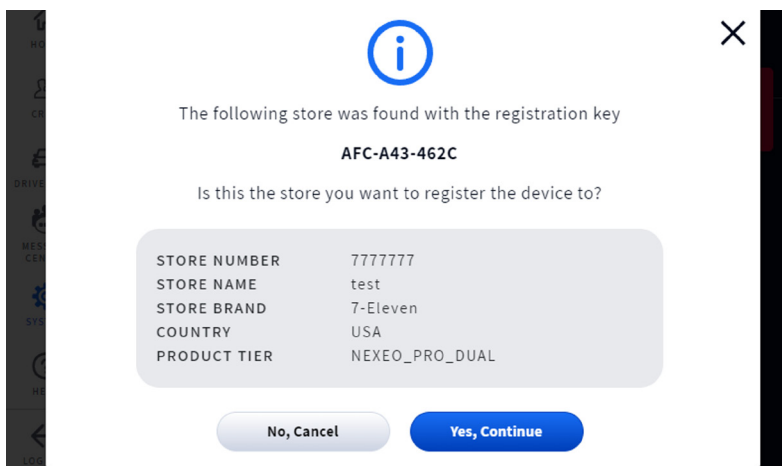

Fig. 3.5

STAGE 3: CONFIGURE

This stage configures the system. Options like Lane Setup, Remote Transceiver positioning, Update Options, and Headset Registration are performed here.

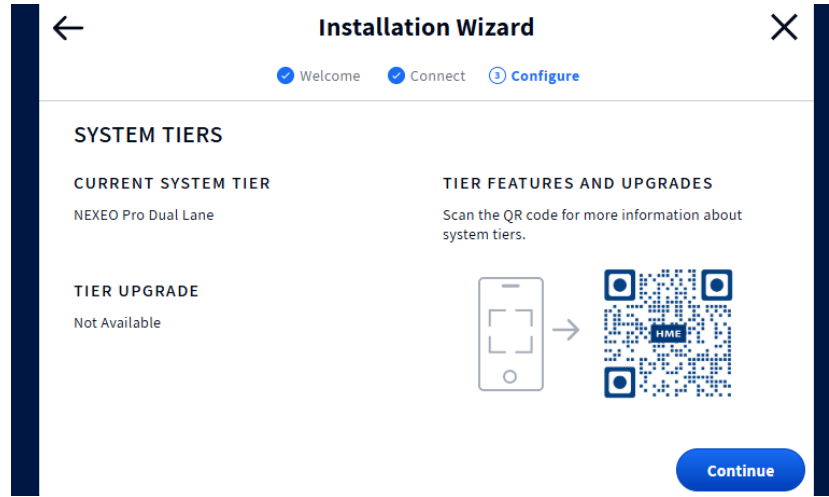

Fig. 3.6

Note: If you accidentally exit the Installation Wizard and need to return to it. Log in to the system, go to the SYSTEM page, and under the TROUBLESHOOTING tab select "Installation Wizard" from the drop-down list. Tap the "Start Installation Wizard" button to begin (see Fig. 3.7).

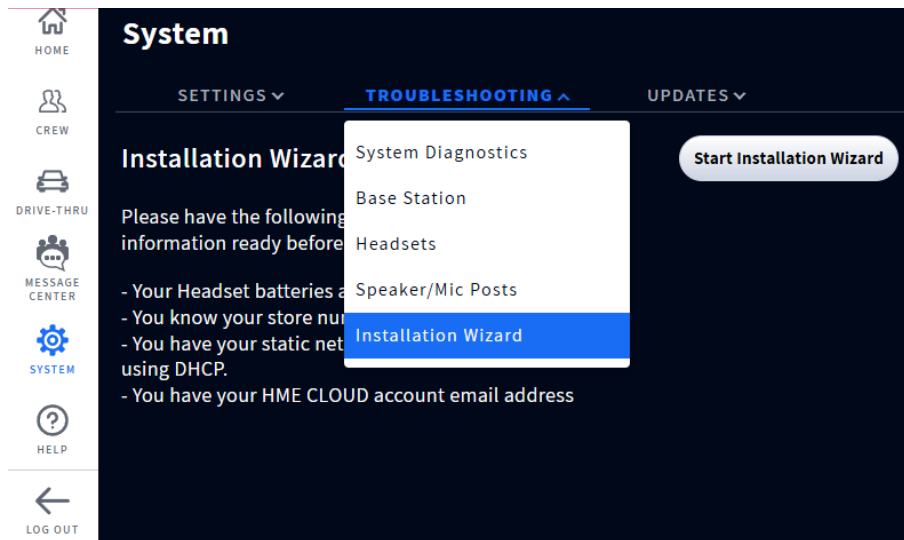

Fig. 3.7

COMPONENT NOTES

CABLE PULLING

All NEXEO orders include a new cable pull installation. While it is possible to use the existing cables from an HME system you are replacing, it is recommended that all NEXEO installations use new cables to ensure optimal performance. The customer is paying for a new system and this includes new cables!



CAUTION: Never run high-voltage cables in the same conduit with audio or loop cables.

1. Run fish tape from inside the building, through the conduit to the speaker post or menu board.
2. Go outside for the cable going to the speaker post. If you are pulling more than one identical cable, mark the cables and spools for identification. Fasten each cable to the fish tape where it comes out of the conduit.
3. Pull the fish tape and cable through the conduit into the building. Disconnect the cable from the fish tape and pull enough of it in to reach the base station.
4. Go outside again and route the cable from the outside conduit to the speaker in the speaker post or menu board.
5. Cut the cable, leaving about 3 feet (91 cm) of slack (or enough length to easily route the cable through the speaker post and terminate it). If more than one cable has been pulled, mark the ends of the cables again for identification.
6. Remove about 2 inches (5 cm) of the out insulation from the end of each cable. Strip about 1/2 inch (12 mm) of insulation from each of the wires in the cable.
7. Route all the cables together to the base station, through walls and over ceiling panels if possible. Make sure that any cable slack is bundled, secured and out of the way if left in the ceiling or elsewhere.

REMOTE TRANSCEIVER (RT7000)

The RT7000 Remote Transceiver (Fig. 4.3) is a required component that facilitates Base Station to Headset communication. It uses a wired connection to the Base Station but is wireless in communicating with Headsets. Up to four RT7000s can be connected to the Base Station to provide greater coverage for larger/multi-level premises.

Installing the Remote Transceiver (RT7000):

- The RT7000 is omnidirectional so mount the RT7000 high in a central location to where the headsets are typically used (see Fig 4.1).
- Maximize line of sight between the transceiver and headsets in an area free from obstructions and equipment/materials that can interfere with signal propagation. These include walls, large metal appliances, hoods, and backsplashes, etc.
- Mount the transceiver vertically on a wall in the upright position (see Fig. 4.4 and orientation arrow on the RT7000 rear). Do **NOT** mount horizontally such as on a ceiling, this will severely reduce the transceiver's range.
- The RT7000 uses an Ethernet (Cat5 or Cat6) cable. Do not exceed 500' (152 m).
- Large premises may require more than one Transceiver. Up to four Transceivers are supported by the

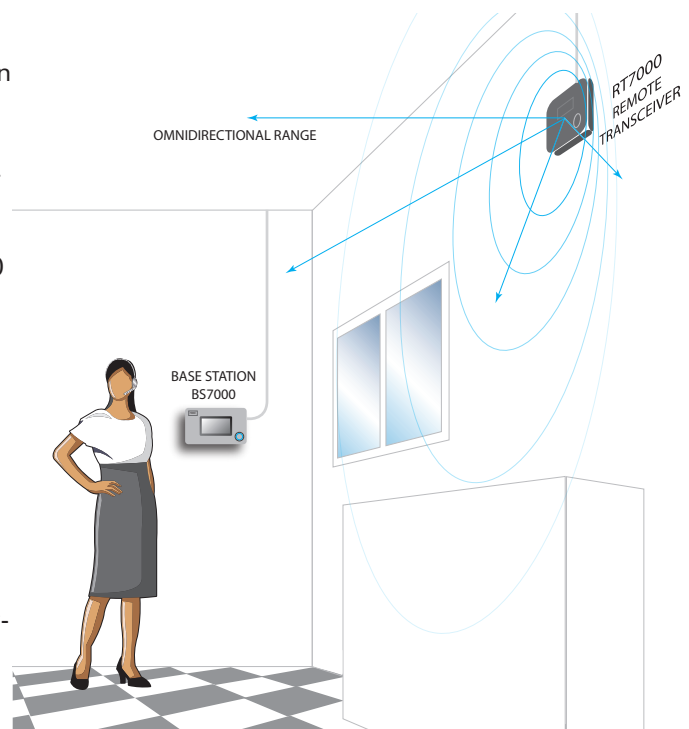

Fig. 4.1

Base Station (PCBA ports: J3200, J3400, J3600, and J3800).

- Once connected to the Base Station, the LED in the middle of the circle on the transceiver front illuminates to indicate it is turned on. One of the outer LEDs (numbered 1 to 4) around the circle also turns on (depending on which port the Transceiver is connected to on the Base

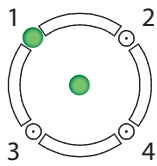

Fig. 4.2

Station, Fig. 4.2 shows the RT7000 connected to the first port (J3200) also see Table 1). This outer LED will initially flash a Magenta, blue or yellow color (see Table 2) as the Transceiver scans for available channels before turning solid green once a channel is found. (On the Base Station HOME screen, the Transceivers' indicator is yellow while scanning before turning green.)

RT7000 TRANSCEIVER
Front View

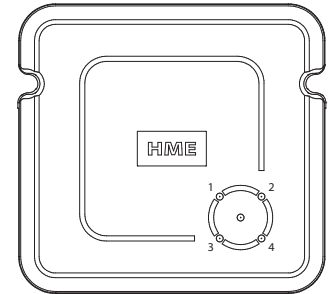

Fig. 4.3

Remote Transceiver ports on Base Station PCBA			
Connector Label	Status/Description	To	LED #
J3200	Remote XCVR Module 1	First RT7000	1
J3400	Remote XCVR Module 2	Second RT7000	2
J3600	Remote XCVR Module 3	Third RT7000	3
J3800	Remote XCVR Module 4	Fourth RT7000	4

Table 1

* RT7000s can be connected to any port in any order and do not have to follow this table.

RT7000 LED Colors with Functional Description	
Color (LEDs 1-4)	Functional Description
Green (Solid)	Ready for use. RT7000 is broadcasting, and Headsets can connect.
Magenta (Blinking)	WiFi Scan.
Yellow (Blinking)	Radar Scan.
Yellow (Solid)	RT7000 is in Test Mode.
Blue (Blinking)	Main radio or Radar1 radio is updating.
Cyan (Blinking)	Radar2 radio is updating.
Red (Solid)	RT7000 has reset and is starting initialization.

Table 2

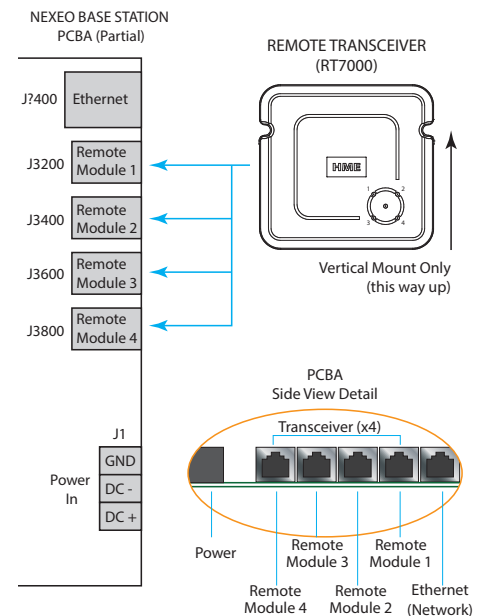

Fig. 4.4

- A surge protector/lightning arrestor is recommended if the RT7000 is mounted outside on an exterior wall. see Fig. 4.5. The ground lug supports up to 12 AWG wire but check with your municipality for local codes on appropriate grounding. With bidirectional protection, either RJ45 jack can be used. Contact HME if one or more are required.

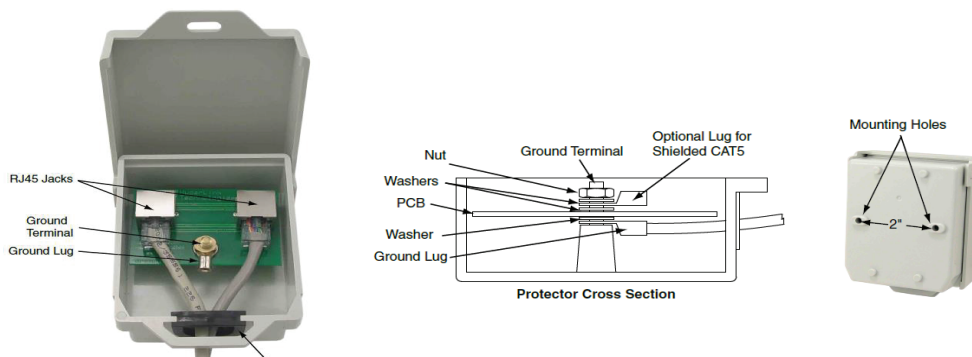

Fig. 4.5

THE SMART BATTERY CHARGER (AC70)

The AC70 Battery Charger can charge up to four BAT70 lithium-ion batteries at the same time. LEDs at the charging ports indicate battery status. Charge time is two hours. The AC70 can be used on a desktop or mounted on a wall.

INSTALLATION/SETUP AND OPERATION



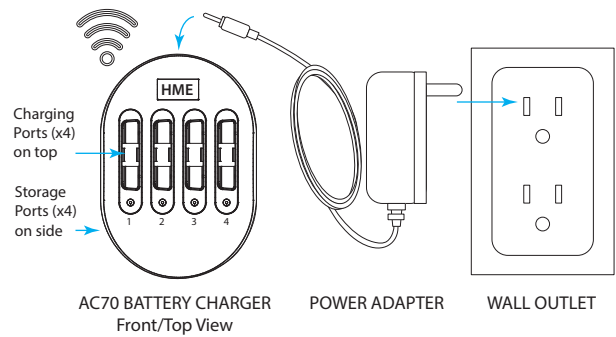

Desktop instructions:

1. Place the AC70 on a level desktop or shelf.
2. Connect the power adapter to a wall outlet, and the other end to the power connector on the AC70 (Fig. 5.1 & 5.2).
3. Position the BAT70 battery correctly for insertion into the AC70 (it is keyed and can only be inserted one way).
4. Insert the BAT70 battery into a vacant port to begin charging. LED activity indicates battery status (see table below).



Note: Only use the HME approved Power Adapter provided.

Fig. 5.1

Battery Charger LED Reference Table		
LED	Color	Status/Description
	Green	Flashing Green = Charging
		Solid Green = Fully charged
	Red	Flashing Red = Incompatible battery
	Red/Yellow	Flashing Red & Yellow (alternating) = Fault condition

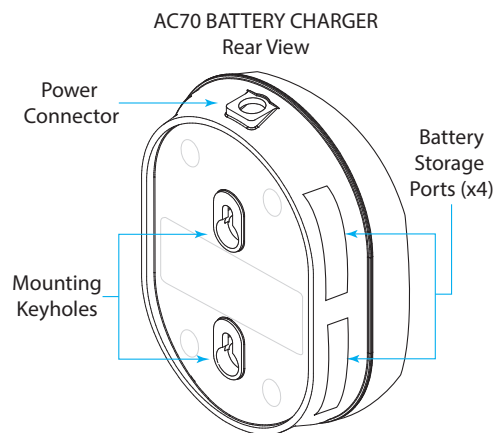



Note: Storage Ports do not charge batteries

Fig. 5.2

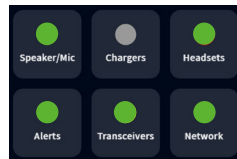
Base Station HOME screen Status Indicators



Note: The AC70 requires close physical proximity (<10 ft (3 m)) to the base station if you desire to monitor battery status via the base station HOME screen. When within range, the Chargers indicator on the HOME screen changes from  to  (gray to green). Once green, tap **Chargers** to view battery status, see Fig. 5.3.

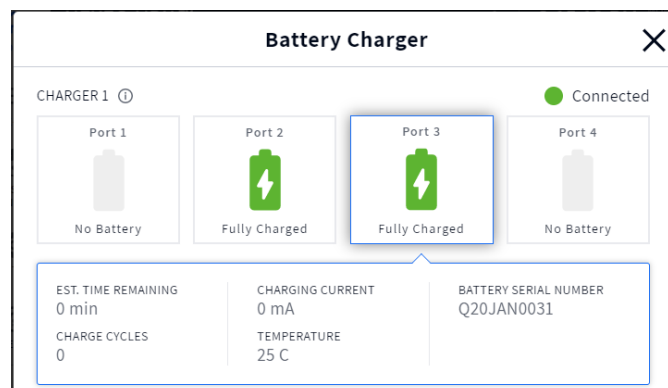

Fig. 5.3

CHANGING POWER SUPPLY ADAPTER

1. Replace power adapter (P/N: CON-00004) to match your country's outlet by using your thumb and forefinger to squeeze in on both sides of the latch (see Fig. 5.4).
2. Continue squeezing latch and slide the adapter out, away from the power supply to remove.
3. Release the latch and slide another adapter on until it bottoms out and the latch clicks to secure it in place.

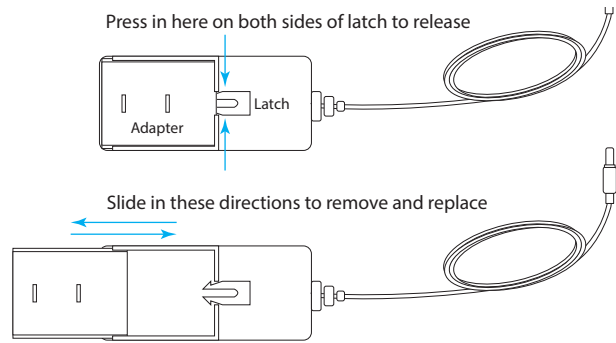

Fig. 5.4

WALL MOUNTING TEMPLATE FOR AC70

1. Hold template (Fig. 5.5) against wall.
2. Use a marker to punch through the paper template at the two crosshairs to mark the wall.
3. Drill two holes at the marks on the wall (avoid electrical or plumbing obstructions).
4. Install the provided hardware but do not tighten, leave a gap ($\sim 1/8^{\text{th}}$ inch (3.2 mm)) between the screw heads and wall.
5. Align the AC70 mounting keyholes with the two screws.
6. Mount the AC70 over the screw heads until flush against the wall, then slide it down onto the screw shanks to secure it in place.

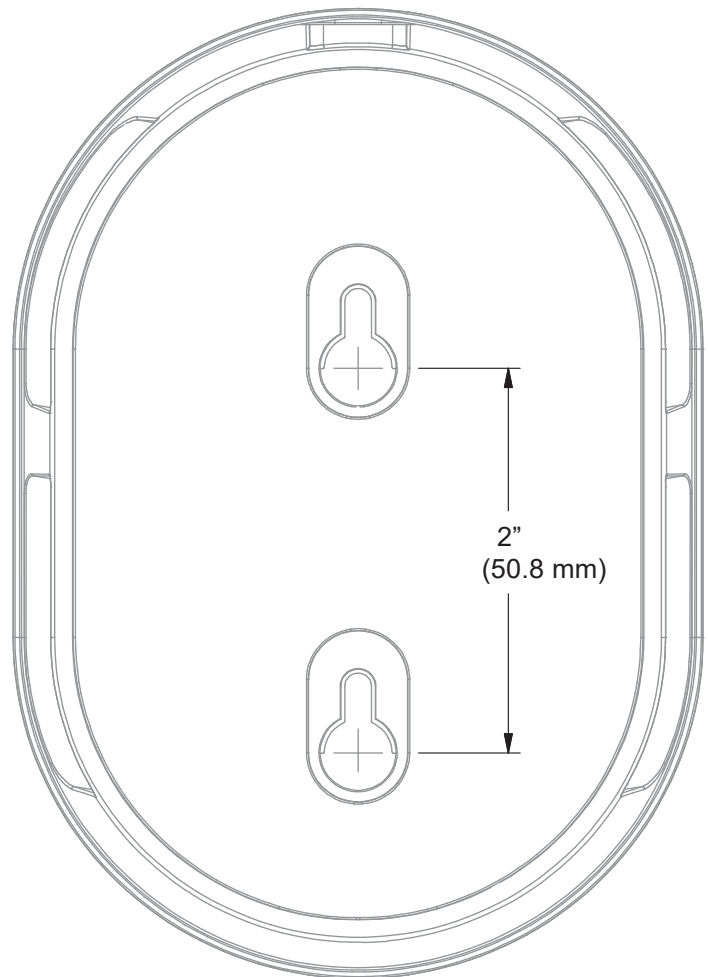

Fig. 5.5

HEADSET (HS7000)

The AIO HS7000 Headset (Fig. 6.1) is an all-in-one headset used to communicate with fellow employees and customers in a drive-thru lane environment. It uses one BAT70 lithium-ion battery. Under normal use, the headset will operate for approximately 8 hours on a single battery charge (new battery) and will alert you when the battery charge is low.

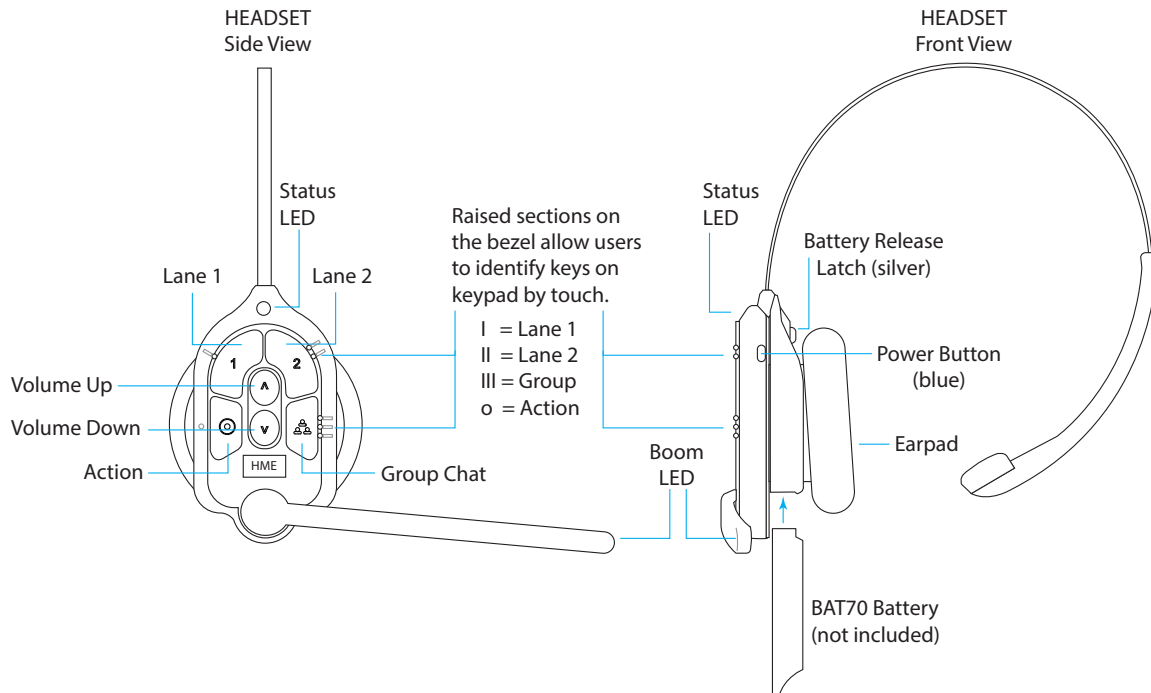

Fig. 6.1

Keypad Reference Table				
Icon	Label	Status LED	Boom LED	Status/Description
1	Lane 1	Green	Green	Tap to talk to lane 1. The Status LED flashes green while the Boom LED turns on solid green (with an audible single-tone confirmation). Tap again to stop (with two-tone confirmation).
2	Lane 2	Red	Red	Tap to talk to lane 2. The Status LED flashes red while the Boom LED turns on solid red (with an audible single-tone confirmation). Tap again to stop (with two-tone confirmation).
	Volume Up			Tap to increase volume (the headset beeps become louder as confirmation). Press and hold to maximize volume to loudest.
	Volume Down			Tap to decrease volume (the headset beeps become quieter as confirmation). Press and hold to minimize volume to quietest.
	Group			Tap for group chat. Both Status and Boom LEDs flash quickly, alternating red & green (with an audible single-tone confirmation). Tap again to stop (audible two-tone confirmation). The Status LED changes to a solid yellow in listening only mode.
	Action			If the headset is set to answer phone calls. Tap once to answer, tap again to end call. Press the 1 or 2 key twice to put the phone call on hold and talk to a respective lane. Press 1 or 2 once respectively followed by the Action key to return to call. Press again to end call.









Notes: Both the Status and Boom LEDs flash slowly alternating colors when the headset needs to be paired. A yellow Status LED indicates a low battery. The low battery Status LED is also accompanied by audio prompts.

Voice commands: See Voice Commands on page 18.

Push-to-Talk mode: Press and hold (continuously) any audio key (L1, L2, or Group) to use in this mode (there is an audible single-tone confirmation). Release to cease communication and exit this mode (there is an audible two-tone confirmation).

VOICE COMMANDS

This option allows headset users to operate their headset using audible commands instead of having to use the headset keypad to do so. Voice commands are not available with NEXEO | Core and also must first be enabled on the base station (SYSTEM>SETTINGS>Voice Commands). This also required for Text and Connect. The following table provides you with a list of available voice commands. All voice commands must be initiated by the command "OK NEXEO" followed (within ten seconds) by the specific command prompt listed in the table below.

Voice Command Table			
How to:	Say:	Status LED	Boom LED
Begin conversation with Lane 1 customer	OK NEXEO, talk to Lane 1	Flashes Green 	Flashes Green 
Begin conversation with Lane 2 customer	OK NEXEO, talk to Lane 2	Flashes Red 	Flashes Red 
Change to listen only to Lane 1 group	OK NEXEO, Lane 1	Solid Green 	Solid Green 
Change to listen only to Lane 2 group	OK NEXEO, Lane 2	Solid Red 	Solid Red 
Set volume level	OK NEXEO, volume # (1-15, 0 is mute)	No effect	No effect
Increase volume or Decrease volume	OK NEXEO, volume up, or volume down	No effect	No effect
Change to the opposite lane's group	OK NEXEO, change lane	To L2 Solid Red, L1 Solid Green	To L2 Solid Red, L1 Solid Green
Person-to-person*	OK NEXEO, call [name of person]		
Call a group/position**	OK NEXEO, call [name of group/position]		

* The person must exist in the Crew Profile directory. First, last, and full names can be used. Tap  on the headset to exit and return to the previous state.

** This needs to be a designated position. Tap  on the headset to exit and return to the previous position.

SETUP AND OPERATION

Note: The HS7000 is wireless and has an optimal range in which signal strength is best. This is dependent on the location of the Remote Transceiver RT7000 and line of sight between both devices.

1. With a fully charged BAT70 battery installed. Press the blue power button to turn on the headset (see Fig. 6.1). The status LED turns on green and blinks, alternating between green and red, indicating you now need to pair the headset.
2. Hold the keypad side of the headset against the Headset Pairing Ring (solid blue circle) on the Base Station to pair. Pairing begins automatically as soon as the headset is sensed. The circular blue light turns a swirling green to indicate pairing is in progress (Fig. 6.2).
3. When the Headset Pairing Ring turns solid green, pairing is successful. If pairing fails, see note.
4. Select your position and begin using the headset.

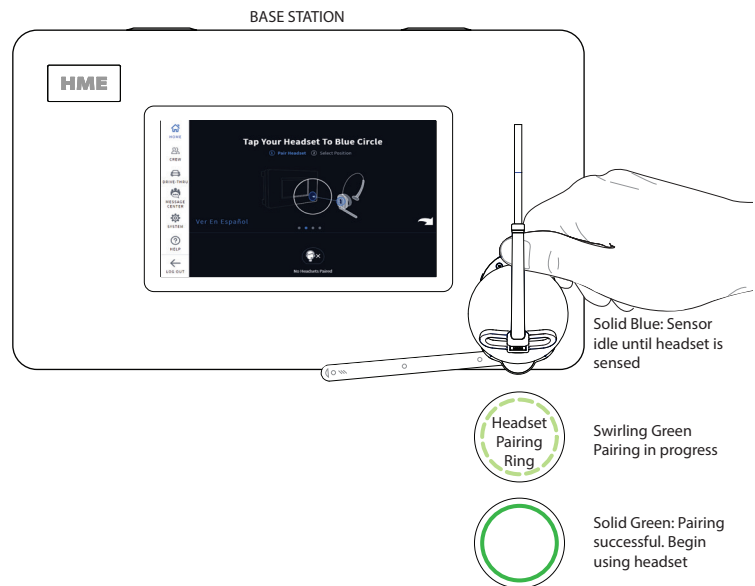

Fig. 6.2

Notes: A swirling red light indicates an unsuccessful pairing. Try again by first verifying that the headset is on, and the battery is fully charged. Hold the headset steadily centered and flush against the Headset Pairing Ring (headset movement and distance from the Pairing Ring can cause pairing errors). A weak battery might also result in pairing issues, replace with a fully charged battery as necessary. Registration automatically happens with the initial pairing.

SPEAKER POSTS AND ENCLOSURES

Before installing the Speaker, Microphone, and IB7000, you must determine where these components will fit.

DEDICATED PVC CONDUIT REQUIREMENTS

The NEXEO cables that run from the Speaker Post to the inside of the store must utilize a dedicated PVC conduit that is at least one inch (25.4 mm) in diameter. One conduit is needed for each lane. Straight runs are recommended. No other wiring or cable may share the HME conduit.

SPEAKER POST/MENU BOARD SIZE REQUIREMENTS

The inner space dimensions of speaker posts/menu boards must be large enough to accommodate three components: a speaker, a microphone, and an interface box. The maximum component **Height = 5.68"**, **Width = 5.76"**, and **Depth = 4.5"**, so you will need a post space with at least that much three-dimensional space to fit any given component (this does not account for the acoustic foam also used to secure the components).

The dimensions of each component are listed under "Specifications" on page 43.

- **Microphone:** The microphone should be installed 42 inches from the ground – (measurements on the average car/truck height where the mic element would meet the middle of the face) - two inches of foam packed around the microphone to prevent vibrations from disturbing it.
- **Speaker:** Once the microphone is placed, the speaker should be at least two feet away from the microphone (below or vertically).
- **IB7000:** The IB7000 is mounted vertically in the post using the adhesive strips (but no foam).

NOTE: If all the components cannot fit comfortably in the post, extra space can be created by installing the components externally using the SPE1 enclosure, which can be attached to a menu board. Only one SPE1 might be required for the speaker, but up to three can also be used if the microphone and IB7000 also need to be installed externally (possible mounting locations are shown below). **DO NOT** install the IB7000 in an SPE1 enclosure shared with another component, because it should not be packed with foam. In the event it needs an enclosure, a separate SPE1 should be used.

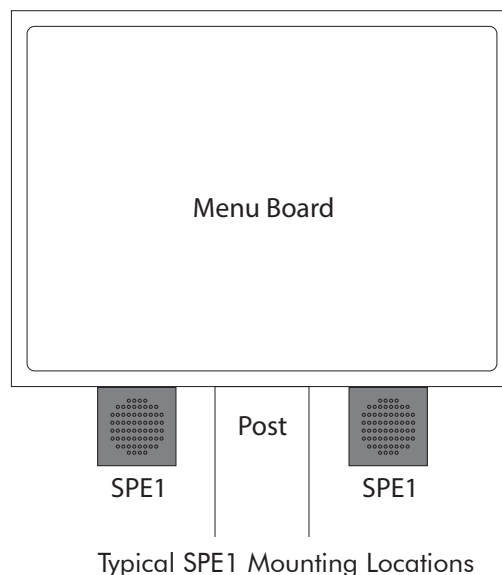

INSTALLING THE IB7000

The **IB7000** interface box is required when you are connecting the DM5 and SS7000 speaker or SP10 speaker to NEXEO. Adhesive strips allow the IB7000 to be affixed to a clean, dry surface inside the speaker post. The max IB7000 cable length to guarantee operation at max volume should not exceed 500 ft (152 m). Fig. 7.2 and also Fig. 2.12 (on page 10) shows how the IB7000 is typically connected.

Note: The IB7000 must be mounted vertically, inside the speaker post close to the speaker/microphone. This will help minimize audio hum and noise (do not mount the IB7000 too far away). If more than one IB7000 is being installed, take note of the serial numbers so you know where each is assigned when configuring on the base station. The power LED illuminates green when the IB7000 is connected to a powered on base station.

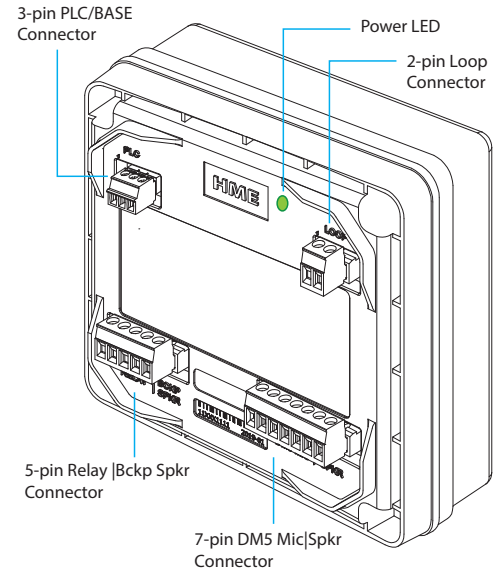

Fig. 7.1

- The two-pin Loop connector connects to the ground loop.
- The three-pin PLC/BASE connector connects to J4500 on the base station. This connection requires the shield/drain to be grounded; see Table 1.
- The seven-pin DM5 MIC | SPKR connector connects to the Microphone and Speaker; see Table 2.
- The five-pin RELAY | BCKP SPKR connector (optional) connects to an intercom system like the IC300 if a backup is needed in the event of a system failure.

IB7000 PLC connector to Base Station J4500 (Spkr/Mic Intrfc)			
Pin #	IB7000 PLC Label	Pin #	Base Station J4500 Label
1	IN1/PL+ (Red wire)	1	Spkr/Mic PL + (Lane 1)
2	IN2/PC- (Black wire)	2	Spkr/Mic PL - (Lane 1)
3*	GND - (Shield/drain)	3	Shield (Lane 1)
1	IN1/PL+ (Red wire)	4	Spkr/Mic PL + (Lane 2 of Y-Lane or Dual-Lane)
2	IN2/PC- (Black wire)	5	Spkr/Mic PL - (Lane 2 of Y-Lane or Dual-Lane)
3*	GND - (Shield/drain)	6	Shield (Lane 2 of Y-Lane or Dual-Lane)

Table 1

IB7000 DM5 MIC SPKR connector to Speaker and Mic			
Pin #	IB7000 Label	Description/wire color	Speaker/Mic labels
1	Mic +	Ext. Microphone positive	DM5 +ve (red)
2	Mic -	Ext. Microphone negative	DM5 -ve (black)
3*	GND	Mic Shield (must be terminated)	DM5 Drain/Shield
4**	I.D.	1-WIRE I/F (Red)	Only for SS7000
5**	GND	Ground (Black)	Only for SS7000
6	Spkr -	Speaker negative (White)	SS7000 or SP10 -ve
7	Spkr +	Speaker positive (Green)	SS7000 or SP10 +ve

Table 2

* The Shield/Drain on the DM5 and audio cable from the IB7000 PLC must be grounded.

** Pins 4 and 5 are only used if connecting an SS7000 speaker (not used with SP10).

INSTALLING THE WEATHER COVER

The IB7000 Weather Cover **must** be installed onto the IB7000 to protect the electrical connections from corrosion due to water/moisture ingress. (Even when installed in a speaker post or menu board, these locations do not guarantee a sheltered environment for the IB7000.)

When installed, the top of the weather cover completely seals the IB7000 on top to prevent water or moisture ingress. The bottom has an opening to allow all the IB7000 cables to exit beneath the IB7000 once the cover is in place.

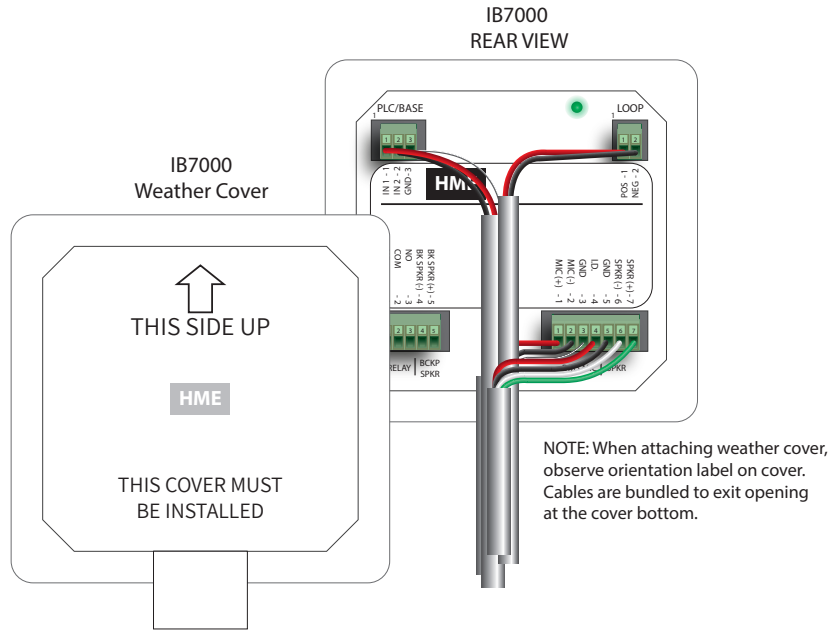

Fig. 7.2

Note: The cover must be oriented and installed the correct way to be effective (see Fig. 7.2).

1. Orient the weather cover correctly before installing (see the up arrow on the cover rear, Fig. 7.2 & 3).
2. Attach the cover by placing the top latch over the ridge and housing seam of the IB7000 (Fig. 7.4).
3. Then, hinge the bottom part of the cover onto the bottom part of the IB7000. If there is resistance, the bottom latches are flexible and can be pried onto the IB7000 (Fig. 7.4).
4. Verify all the IB7000 cables exit through the opening at the cover bottom before pressing in on the cover to close. The cover will snap securely into place (Fig. 7.5).

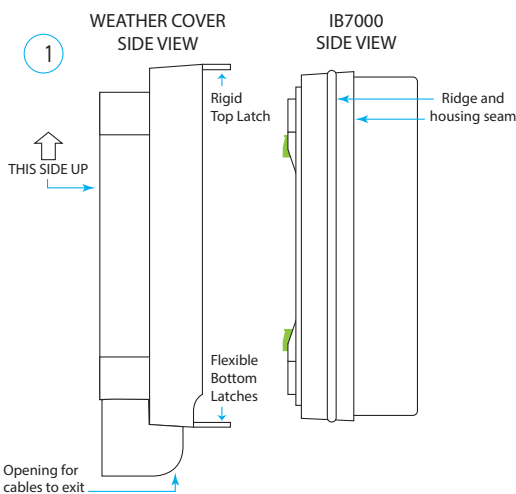

Fig. 7.3

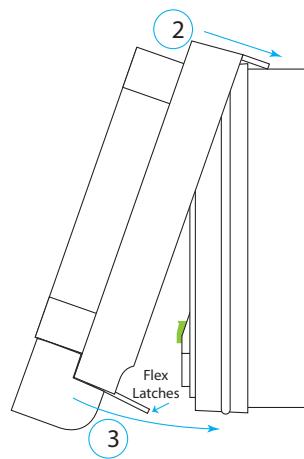

Fig. 7.4

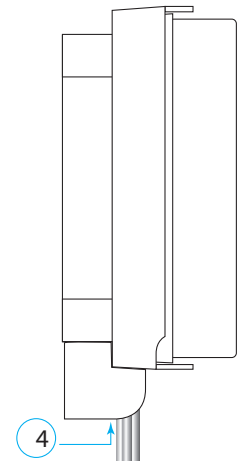

Fig. 7.5

Note: To remove the cover, do so in reverse order to the above steps. First, use your fingers to pry the flexible latches on the cover bottom as you detach it from the IB7000 ridge and housing seam it is gripping. Hinge outward away from the IB7000 until the top freely detaches.

INSTALLING THE MICROPHONE AND SPEAKER

THE DM5 MICROPHONE

The DM5 must be used in conjunction with the IB7000 interface box (i.e., the Microphone does not connect directly to the base station).

- See Fig. 2.12 on page 10 for visual reference and IB7000 section for wiring tables.

Typical DM5 Microphone installation involves placement of the microphone in a molded foam enclosure and mounting it inside the upper compartment of the speaker post. You will fill the empty space behind the unit with acoustic foam. If the DM5 is mounted in a small area, its molded foam enclosure may need to be compressed in order to close the compartment. Follow these instructions to install the DM5 in a typical speaker post or menu board.

1. Open the speaker post and remove any existing equipment, foam or debris. If there is an existing microphone, remove it and disconnect the microphone cable.
2. Remove the small portion of the provided foam microphone enclosure, resulting in the two pieces of foam shown in Fig. 8.2.
3. Insert the DM5 Microphone cable through the hole in the foam enclosure, and place the microphone into the hole as shown in Fig. 8.2.
4. Insert the removed piece of foam back into the hole in the foam enclosure to fit snugly against the back of the microphone, as shown in Fig. 8.2.
5. Using a serrated knife, trim the foam enclosure so it is $\frac{1}{4}$ to $\frac{1}{2}$ inch larger than the upper speaker post compartment (vertically and horizontally) for a compressed fit. Keep the foam pieces to fill the compartment (if needed).
6. Place the foam windscreen in front of the microphone, positioning it to cover the inside of the speaker grill as shown in Fig. 8.3.
7. Place the foam enclosed microphone into the compartment, so the front of the microphone windscreen is flush against the metal, centered on the grill, see Fig. 8.3.
8. The DM5 wires are connected to terminals 1, 2, and 3 of the seven-pin DM5 MIC | SPKR connector on the IB7000. See Fig. 2.12 and "Wiring connections (Not all connections are required)" on page 4.
9. Pack acoustic foam in the empty space behind the DM5 Microphone and its foam enclosure, filling the space.



Fig. 8.1

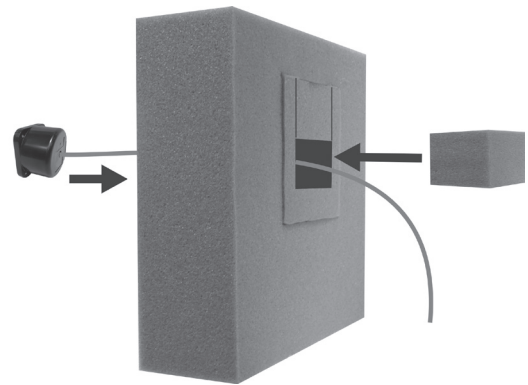

Fig. 8.2

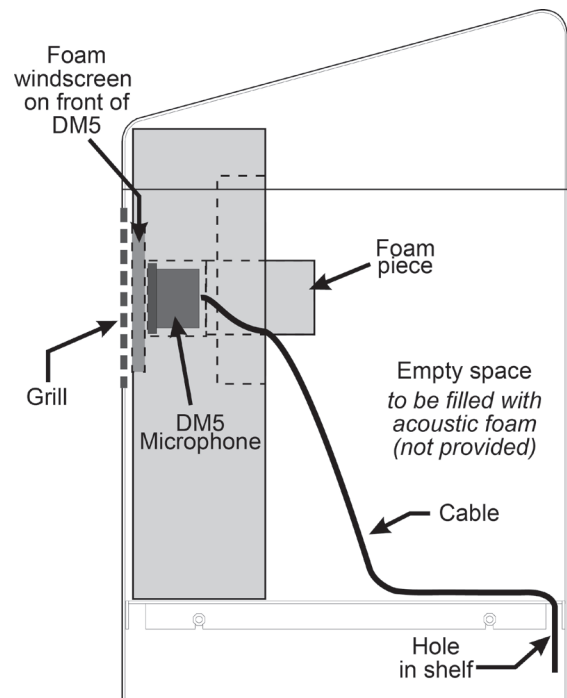

Fig. 8.3

THE SS7000 SPEAKER (STANDARD, IF NOT USING THE SP10)

The SS7000 must be used in conjunction with the IB7000 interface box (i.e., the speaker does not connect directly to the base station).

- See Fig. 2.12 on page 10 for visual reference and IB7000 section for wiring tables.

These instructions are for a typical installation.

1. Strip approximately 1 inch (25.4 mm) of insulation from the end of the audio cable and $\frac{1}{4}$ inch (6.35 mm) of insulation from each of the four cable wires, but do not tin the wires. Connect the audio cable wires to the connector plug (the speaker connector is labeled).
 2. Insert the connector plug into the speaker connector (see Fig. 9.2).
 3. Position the speaker inside the speaker post or menu board, with the gasket centered against the inside of the speaker grill, as shown in Fig. 9.3. Align the opening in the gasket with the grill opening.
 4. Remove both inserts from the molded foam enclosure and place the foam enclosure around the speaker. Trim foam with a serrated knife if necessary. Place removed foam inserts behind speaker to provide pressure to speaker, to ensure a good gasket seal against the speaker grill opening.
 5. Connect the other end of the audio cable to the IB7000. The four wires on the SS7000 connect to terminals 4,5, 6, and 7 of the seven-pin DM5 MIC | SPKR connector on the IB7000 (this connector is labeled on the IB7000), see Fig. 2.11.
 6. Connect audio cable between the three-pin PLC/BASE connector on the IB7000 and J4500 on the base station (this connector is also labeled on the IB7000). See Fig. 2.12 and “Wiring connections (Not all connections are required)” on page 4.
- Note:** You may be able to use the existing audio cable if replacing an older HME system like EOS. Verify the cable is in good condition before doing so.



Fig. 9.1

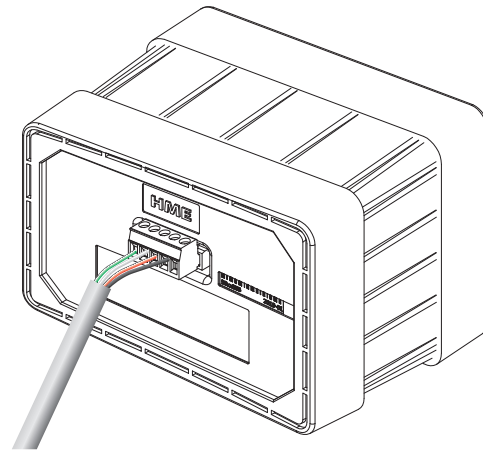

Fig. 9.2

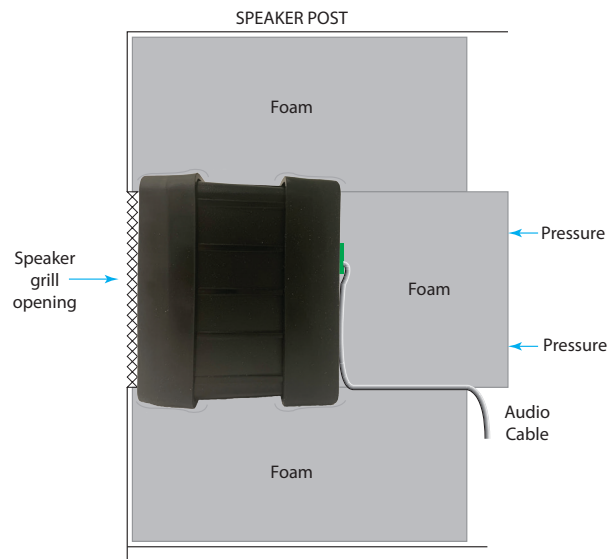

Fig. 9.3

THE SP10 SPEAKER (OPTIONAL, IF NOT USING THE SS7000)

The SP10 must be used in conjunction with the IB7000 interface box (i.e., the speaker does not connect directly to the base station).

- See Fig. 2.12 on page 10 for a visual reference and IB7000 section for wiring tables.
1. Strip approximately 1 inch (25.4 mm) of insulation from the end of the speaker cable, and ¼ inch (6.35 mm) of insulation from each of the two cable wires, but do not tin the wires. Connect the speaker cable wires to the connector plug as shown in Fig. 10.2. Insert the connector plug into the connector on the speaker as shown in Fig. 10.2.
 2. Remove the double-stick tape liner, and press the adhesive side of the gasket against the front of the speaker in the position shown in Fig. 10.2.
 3. Position the speaker inside the speaker post or menu board, with the gasket centered against the inside of the speaker grill as shown in Fig. 10.3. The cable connector can be routed to either side. Align the opening in the gasket with the grill opening.
 4. Remove both inserts from the molded foam enclosure and place the foam enclosure around the speaker. Trim foam with serrated knife if necessary. Place the removed foam inserts behind speaker to provide pressure to speaker, to ensure a good gasket seal against the speaker grill opening.
 5. The SP10 wires are connected to terminals 6 & 7 of the seven-pin DM5 MIC | SPKR connector on the IB7000 (this connector is labeled on the IB7000).
 6. Connect audio cable between the three-pin PLC/BASE connector on the IB7000 and J4500 on the base station (this connector is also labeled on the IB7000). See Fig. 2.12 and “Wiring connections (Not all connections are required)” on page 4.
Note: You may be able to use the existing audio cable if replacing an older HME system like EOS. Verify the cable is in good condition before doing so.



Fig. 10.1

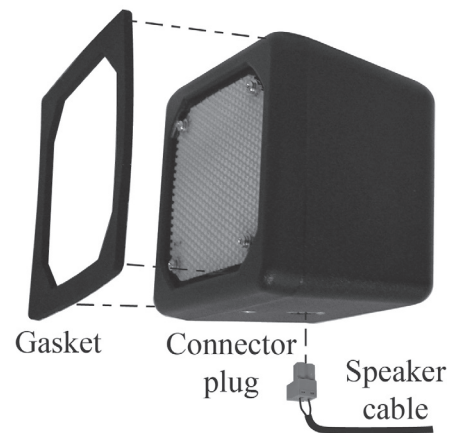

Fig. 10.2

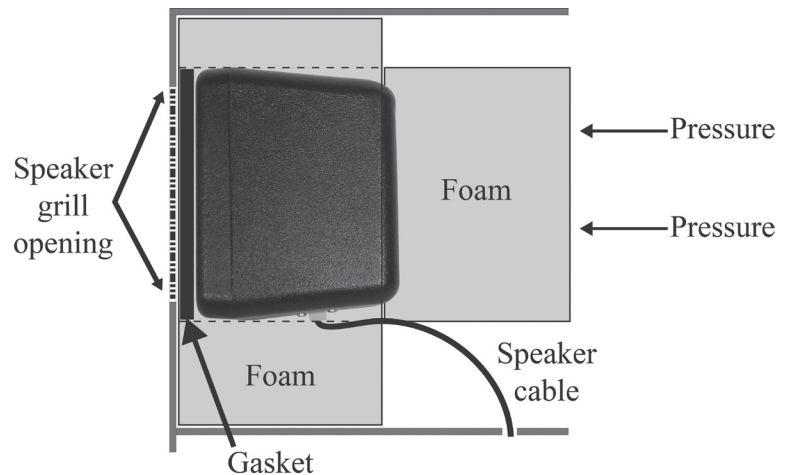

Fig. 10.3

INSTALLING THE TI7000 TELEPHONE INTERFACE (OPTIONAL)

The TI7000 links a telephone to a NEXEO | HDX™ system so that one designated headset can also be used to answer incoming phone calls.

WHAT'S INCLUDED

- One TI7000 Telephone Interface
- Two Cables (Cat5 Base Station, RJ11 Telephone)
- One Jack Splitter
- Mounting Hardware

TOOLS/EQUIPMENT REQUIRED (wall mounting only)

- Drill and drill bits (~ 3/16th inch (4.8 mm))
- Screwdrivers (Phillips #2 and small slotted)
- Wire cutter/stripper and safety glasses

INSTALLATION AND SETUP

Note: The base station interface cable is short (3 ft (0.91 m)). Mount the TI7000 close to the Base Station.

Wall mount instructions:

1. Hold the TI7000 against the wall and mark the wall through the two mounting holes on each end of the unit (see Fig. 11.1).
2. Drill two holes at the marked locations (avoid electrical or plumbing obstructions).
3. Insert the included screw anchors until flush with the wall. Use a screwdriver to securely mount the TI7000 to the wall using the included hardware.

Connections:

1. Unplug the store telephone from the wall port and plug the included telephone jack splitter into the same wall port.
2. Plug the telephone into one of the ports on the telephone jack splitter, see Fig 11.1.
3. Plug one end of the included telephone interface cable into the other port on the telephone jack splitter and connect the other end to the RJ11 port on the TI7000. See Fig 11.1 and 2.
4. Plug one end of the included base station interface cable into the RJ45 port on the TI7000. Open the base station and connect the other end to J201 on the base station PCBA. See Fig. 11.3 for J201 location.)



Note: The TI7000 can only be used with a land-line, and is only for use in the US and Canada.

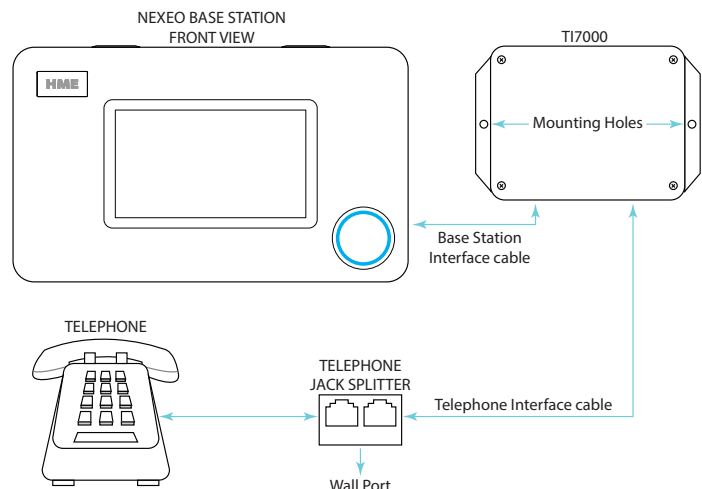

Fig. 11.1

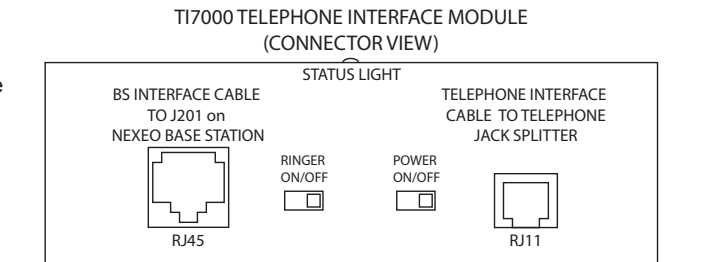





Fig. 11.2

OPERATION:

To set your headset to answer phone calls:

1. Set the POWER and RINGER switches on the TI7000 to the ON position (the RINGER switch enables you to hear the telephone ring tone on the headset). The TI7000 status light turns on and remains a steady red (until an incoming call).
2. Log in to the NEXEO base station and go to **SYSTEM>SETTINGS**. Select Telephone Interface from the drop-down list, see Fig. 11.4. Toggle the OFF switch ON. The recommended default values are set to 10. If necessary, the volume levels can be adjusted using the sliders.
3. Pair your headset (and select name if prompted or continue as guest).
4. When the **Select Your Position** dialog appears, select a position and check the box labeled: **Allow this headset to receive telephone calls**. See Fig. 11.5. (Since only one headset can be designated to receive phone calls, checking the box forces any previous headset assigned out of this mode.)
5. The headset  (Action) key is used to answer phone calls. Incoming calls will ring on the headset, and the TI7000 status light will slowly alternate between red and green.
 - **To answer a call:** tap the  key once (the TI7000 status light turns a steady green). The headset status LED turns a steady blue while the mic boom flashes blue.
 - **To end a call:** tap the  key again (the TI7000 status light reverts to a steady red).
 - **To place call on hold and speak to a lane:** Tap the 1 or 2 key **once** to place the call on hold, this returns the headset to idle mode. Tap the 1 or 2 key again to speak to lane 1 or 2, respectively. To return to the call, tap the  key. To end call, tap again.

Note: Fig. 11.6 shows the location of two potentiometers and a DIP Switch on the TI PCBA. These potentiometers are factory set and should not need to be adjusted, but if they do, unscrew the four screws on the front cover of the TI7000 with a Phillips (crosspoint) screwdriver. Adjust R58 for the ring level and/or R62 for the voice level as needed. Clockwise turns increase volume, while counterclockwise turns decrease volume. Call the store phone again to check out the ring or voice level. Replace the cover on the unit when you are satisfied with the ring/voice level.

The DIP Switch is set for NEXEO by default. Switch #2 is set in the ON position, Switches 1, 3, and 4 are OFF.

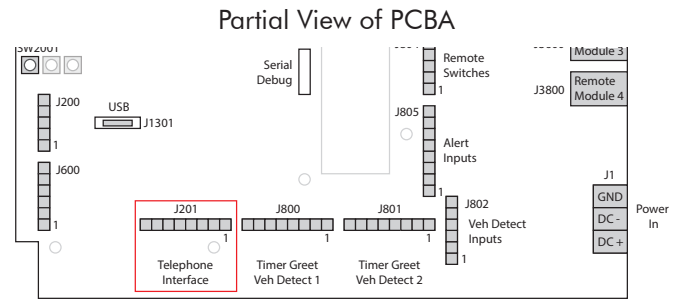

Fig. 11.3

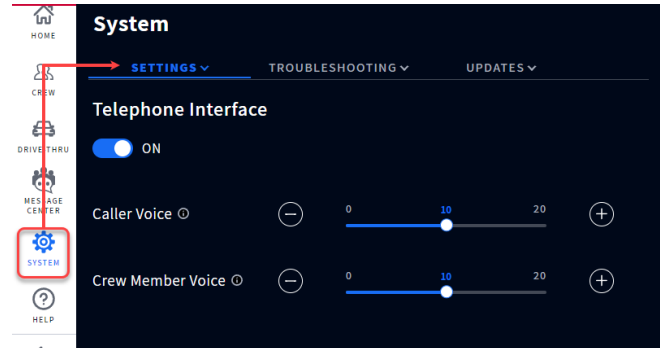

Fig. 11.4

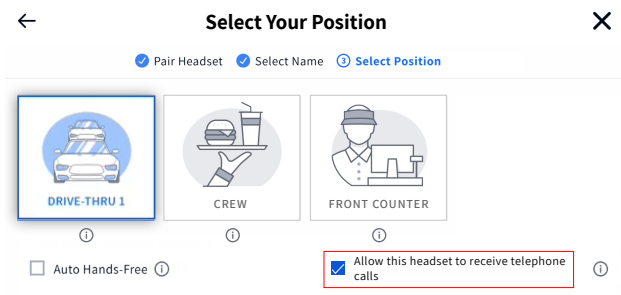

Fig. 11.5

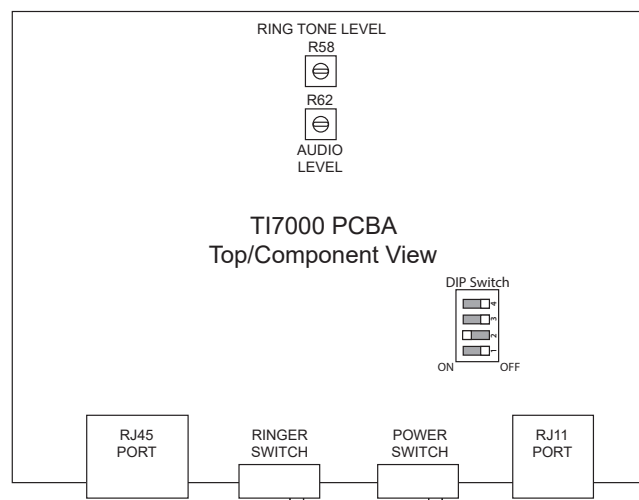

Fig. 11.6

AOT (AUTOMATED ORDER TAKING)

Automated Order Taking (AOT) requires a NEXEO Pro subscription and a connection with a service provider. It's an AI feature that uses a bot to take customer orders in the drive-thru so that staff are available to perform other roles in the restaurant. It is disabled by default. Please contact brand/chain administration for more information.

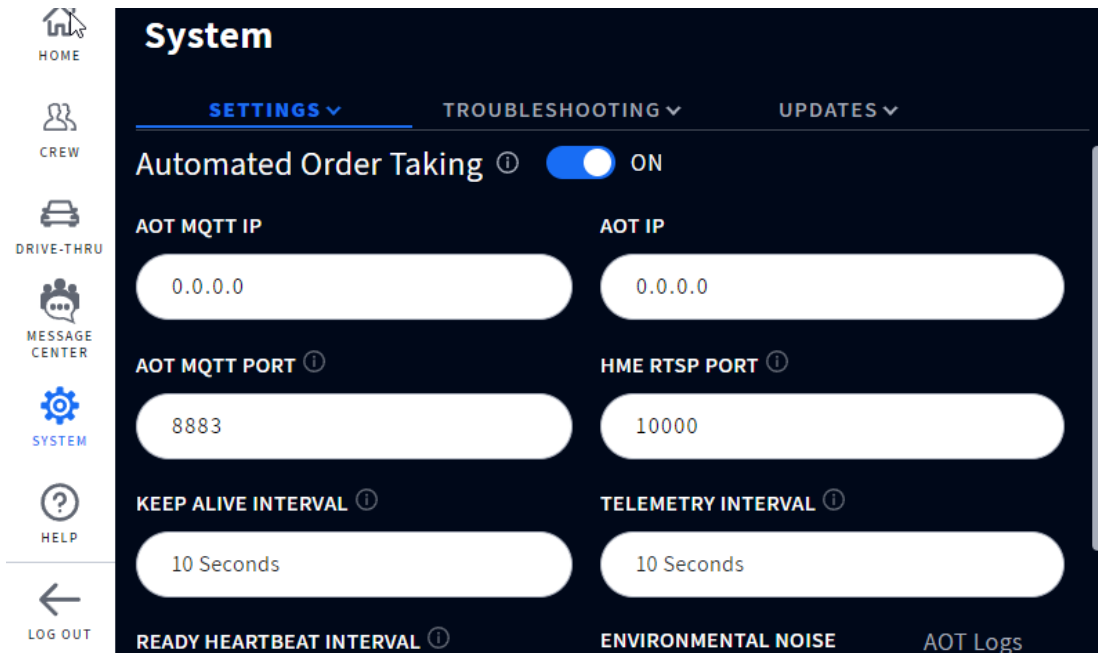

Fig. 12.1

Automated Order Taking: Toggle the OFF switch to ON to enable.

AOT MQTT IP: The IP of the MQTT broker. Any valid IP v4 is accepted. The default value is 0.0.0.0.

AOT IP: This setting is for future use and is not required at this time. The default value is 0.0.0.0.

AOT MQTT PORT: This is the port used by the MQTT Broker to listen to client connections. Valid values are 8883 and 1883. The default value is 8883.

HME RTSP PORT: This is the port used by the Streaming Server to listen to streaming client connections. Accepted values are integers between 1024 and 65535. The default value is 10000.

KEEP ALIVE INTERVAL: This is the interval in seconds, used to send keep alive messages to keep the MQTT connection open with the MQTT Broker. A value of 0 will deactivate this mechanism. Values between 0 and 120 are accepted. The default value is 60.

TELEMETRY INTERVAL: This is the interval in seconds, used to send Telemetry messages to the MQTT Broker. A value of 0 disables the Telemetry messages. Values between 0 and 120 are accepted. The default value is 60.

READY HEARTBEAT INTERVAL: This is the interval in seconds, used to send the Heartbeat messages to the MQTT Broker. A value of 0 disables the Heartbeat messages. Values between 0 and 120 are accepted. The default value is 60.

ENVIRONMENTAL NOISE REPORTS: This is disabled by default. When enabled, NEXEO will send reports concerning environmental noise around the drive-thru posts.

AOT Logs Download: Allows you to download AOT files for archival purposes. The file format is .tar.gz.

NITRO ALERTS

The customer must have an HME ZOOM Nitro® timer installed to use this setting. NEXEO | HDX AUDIO ALERTS must also be enabled on the HME ZOOM Nitro timer. Please consult the how-to instructional guide: *Configuring ZOOM Nitro to NEXEO | HDX Alerts* online in the Supporting Documents Library of HME’s Training Portal, or please contact HME Support at 1 800 848 4468 for more details. Visit the library using this link: <https://www.hme.com/training/supportingdocuments/?lng=1>

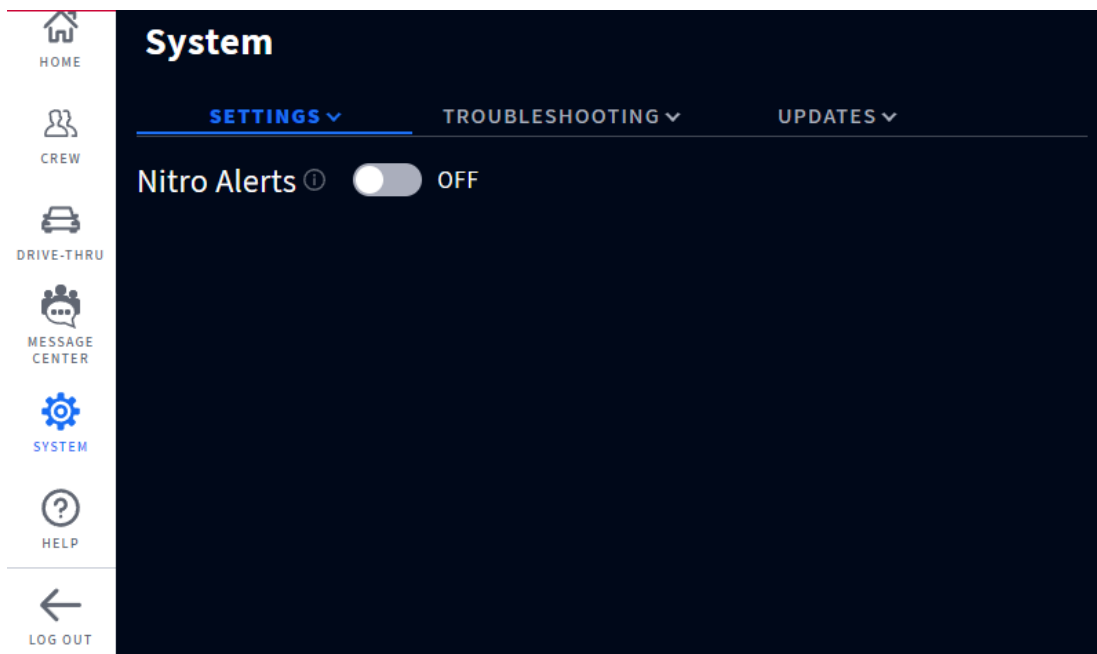

Fig. 13.1

This is disabled by default (Fig. 13.1). Toggle the switch to ON to enable. The HME ZOOM Nitro timer can be configured to play messages/notifications on NEXEO headsets. When ZOOM Nitro® alerts have been configured on the timer system, they show up in the TYPE column on the MESSAGE CENTER>MESSAGES page as “Nitro Alert.”

HELP

HME Technical Support: If the help provided in this section is not sufficient, please contact our Technical Support team at support@hme.com or call us at 1-800-848-4468. As a valued customer, we are here to help you have the best experience with your product; your success is our success!

TROUBLESHOOTING

Problem	Solution
The Base Station is off (blank screen)	<p>The Base Station does not have a power on/off button, it turns on automatically once it is plugged into a live outlet.</p> <p>Verify the power adapter is plugged into a live wall outlet.</p> <p>Verify the power cable is properly terminated to J1 on the Base Station PCBA and that there is power from the power adapter to this end of the cable (illuminated LEDs on the PCBA indicate there is power to the base station).</p>
The Base Station is on but not responsive to certain actions	<p>Log in to the base station, go to SYSTEM, click on the troubleshooting tab, select from the menu and try restarting the component that is not responsive. Restarts can take several minutes to complete.</p>
The entire HOME screen is not responsive to touch	<p>Try a hard reset by unplugging the power cord from the wall outlet. Wait a few seconds and then reconnect power. Reboots can take several minutes to complete.</p>
The headset does not power on	<p>Verify the BAT70 battery is fully charged and not dead (verify charge in AC70).</p> <p>Verify the BAT70 battery is inserted correctly and properly docked (you should hear an audible click when it is properly inserted and securely seated).</p> <p>Verify the Power button depresses when pressed.</p> <p>Verify the battery contacts in headset battery holder and on the battery are clean and free of debris.</p> <p>Verify the battery is the correct type (only HME BAT70 batteries are valid, the battery is labeled on the back),</p>
The headset does not pair	<p>Verify the headset has a sufficiently charged battery and that the headset is powered on (the headset status LED illuminates).</p> <p>Hold the headset steady, centered, flush against the headset pairing ring. Movement and proximity can cause pairing failures.</p>
The headset has no sound	<p>Verify the headset is on.</p> <p>Verify the headset is paired.</p> <p>Verify the headset is within range of the transceiver.</p> <p>Press and hold the volume up button on the headset keypad, an audible beep gets louder as volume increases.</p>
Headset communication is choppy or drops off	<p>Headsets have an effective range based on the location of the RT7000 transceiver. Move the headset to within range of the transceiver.</p> <p>Large objects can also interrupt signal propagation. Try moving to a different location.</p> <p>Verify the headset has a charged battery.</p>

Problem	Solution
Headset battery will not charge	<p>Verify the charger is plugged in and on.</p> <p>Verify the battery is the correct type (BAT70).</p> <p>Verify the battery is docked correctly in the port (the battery is keyed so it can only be inserted one way. It should not be forced into the charging port).</p> <p>Verify the battery and charger contacts are clean and free from debris, contaminants, or obstructions.</p> <p>Verify battery is not dead. Batteries have lifespan, they will eventually die and will need to be replaced. The Base Station monitors battery charge cycles and informs you when to replace a battery. The AC70 needs to be within 10' (3 m) of the Base Station to monitor battery status.</p>
RT7000 Transceiver not working	<p>Verify that the Ethernet cable is good, and connected on both ends. The RT7000 Power LED illuminates when the Base Station is on.</p> <p>When disconnecting the RT7000 from a Base Station that is powered on, you must wait at least 30 seconds before reconnecting the RT7000 Ethernet cable. This allows the system time to sense the disconnection and turn power to the port off. Reconnecting to a live port can damage the circuitry. If a port is damaged, try connecting to another one.</p>







AOT TROUBLESHOOTING

Problem	Solution
Audio streaming is not flowing between NEXEO and the QSR Audio Service	<ul style="list-style-type: none"> • Verify that IB7000 version is 2.11.4 or higher and they are connected to the base. • Verify in AOT Settings screen that Automated Order Taking is enabled, MQTT IP and PORT are set correctly, and RTSP Port is configured using the value used by the QSR Audio Service to connect to the Streaming Server. • Download AOT logs and verify that MQTT is sending messages correctly (Heartbeat, Telemetry, Arrivals, etc). Then validate that the Streaming Server is up and running and that streaming client's connection is established. • Re-start the NEXEO base if MQTT or Streaming Server are not responding (not logging any information).
Audio streaming is not flowing between QSR Audio Service and NEXEO	<ul style="list-style-type: none"> • Verify in AOT Settings screen that Automated Order Taking is enabled, and RTSP Port is configured using the value used by the QSR Audio Service to connect to the Streaming Server. • Validate that the IB7000 is connected to the base. • Validate that there is not headset connected to that lane with the microphone open. • Download AOT logs and verify that the Streaming Server is up and running and that streaming client's connection is established. • Re-start the NEXEO base if Streaming Server is not responding (not logging any information)

Problem	Solution
Escalation tones are not playing	<ul style="list-style-type: none"> • Verify that there is a car present on the lane where the escalation should be played. • Verify that the escalation messages are present on the base, going to the Message Center, and validating that the 4 AOT Escalation messages are available. • Verify that the audio files associated with the escalation messages are also present on the base, going to the Message Center -> Audio Files tab, and validating that the 2 AOTEscalation files are there. • Download AOT logs and verify that the MQTT escalation message has been received on topic aot/request/auto-escalation/lane1 or aot/request/auto-escalation/lane2.
MQTT Telemetry and Ready messages are not being sent, while other messages are	<ul style="list-style-type: none"> • Download AOT logs and verify that the StreamingServer is up and running. • Send a re-start command via MQTT message from the QSR MQTT services. • Re-start the NEXEO base if Streaming Server is not responding (not logging any information).

LEDs

The System uses LEDs on components to indicate the status of the device.

LED	Description
AC70 Charger: RED LED 	<p>A  (flashing red) LED indicates an unauthorized or unrecognized battery. Only HME approved (p/n BAT70) lithium-ion batteries can be used with your system.</p> <p> Caution: Batteries not approved by HME will not charge properly and can cause damage to the system, including explosions with the potential to shock, inflict personal injury and/or start fires.</p> <p> HME cares about the environment. Please check with your municipal laws, regulations, and guidelines for the proper disposal of dead lithium-ion batteries.</p>
AC70 Charger: RED/YELLOW LED  	Flashing Red & Yellow (alternating)= Fault condition other than an unrecognized.

If you cannot resolve problems with the information presented here, please contact HME Technical Support at 1-800-848-4468.

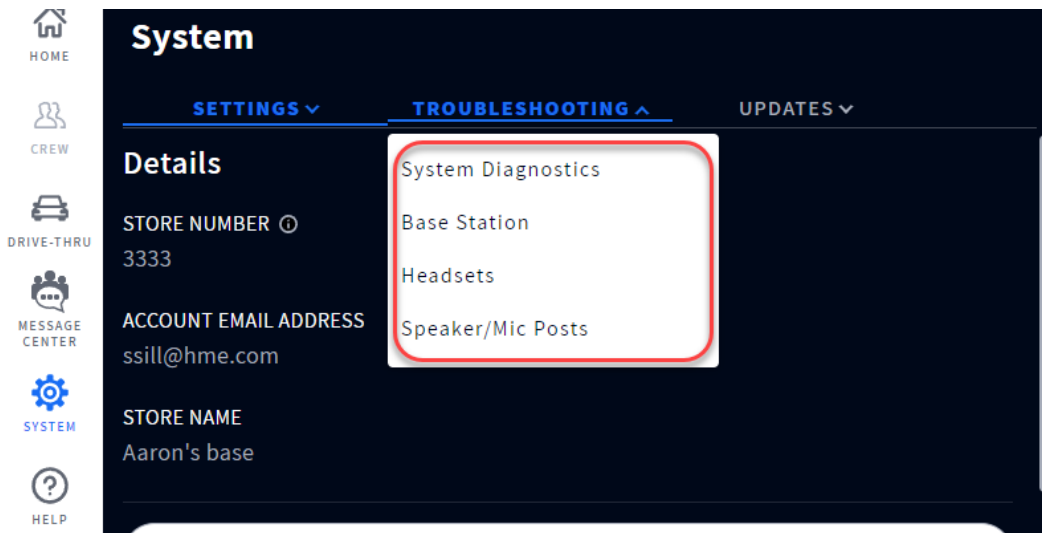
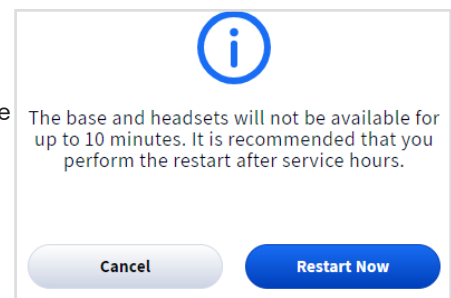

Fig. 14.1

What is this screen for? This screen provides you with system and component information that can help you troubleshoot when issues arise. Tap on the tab to open the drop-down list and select the option you wish to view. The information below covers the options in the Fig. 14.1 drop-down list.

System Diagnostics: This provides you with a breakout of your system components and feedback on the health of your system. Click on Base Station, Network, Audio, Speaker/Mic Posts, or AOT for details. See System Diagnostics Continued for more information.

Base Station: This gives you a profile of your Base Station, including serial number and firmware version. You can also restart the Base Station from here without having to disconnect and reconnect power. Press the Restart Base Station button, and this prompt appears suggesting to do this after service hours since the system may take several minutes to reboot.



Headsets: This lists all headsets connected to or disconnected from the Base Station. Click on the More icon at the end of the row and select View Details to see additional details for any listed headset.



Speaker/Mic Posts: This gives you a profile of your Speaker/Mic, including serial number and firmware version. You can also restart the Speaker/Mic from here without having to disconnect and reconnect power. Press the Restart Speaker/Mic Post button, and a prompt appears suggesting to do this after service hours since the system may take several minutes to reboot.

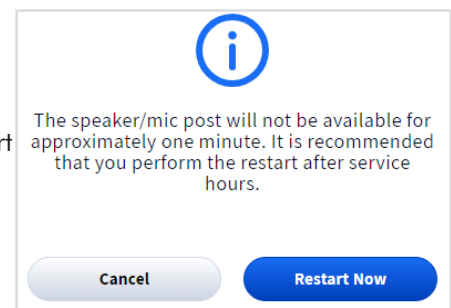

System Diagnostics continued: Valuable feedback on the health of each component can be found by clicking on any of the component options listed under System Diagnostics in Fig. 14.2 (i.e., Base Station, Network, Audio, Speaker/Mic Posts, and AOT).

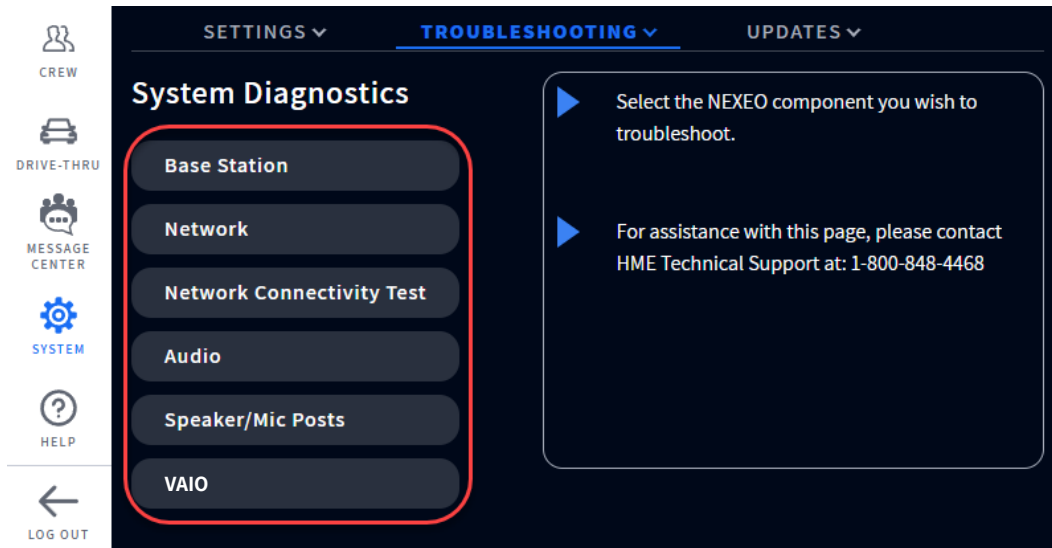

Fig. 14.2

Figure 14.3 is an example of what you see when you click on the Base Station option. This diagnostics section provides useful information for Technical Support when an issue occurs.

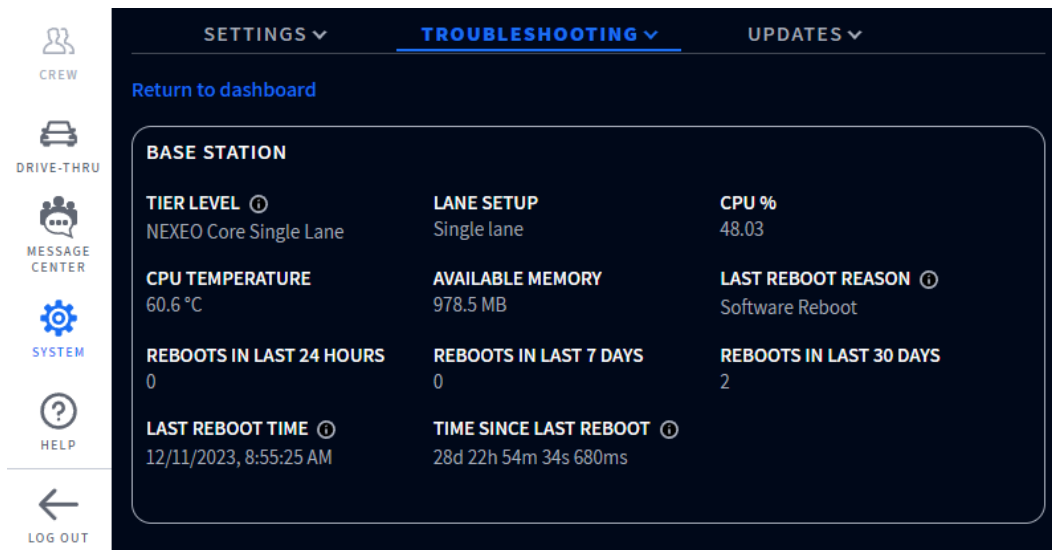

Fig. 14.3

Figure 14.4 is an example of what you see when you click on the Network option. Scroll down further to view more details. This page also includes a Network Test, which can be performed by clicking on the Start Test button to the right. Fig. 14.4 show this test performed with results displayed below the button.

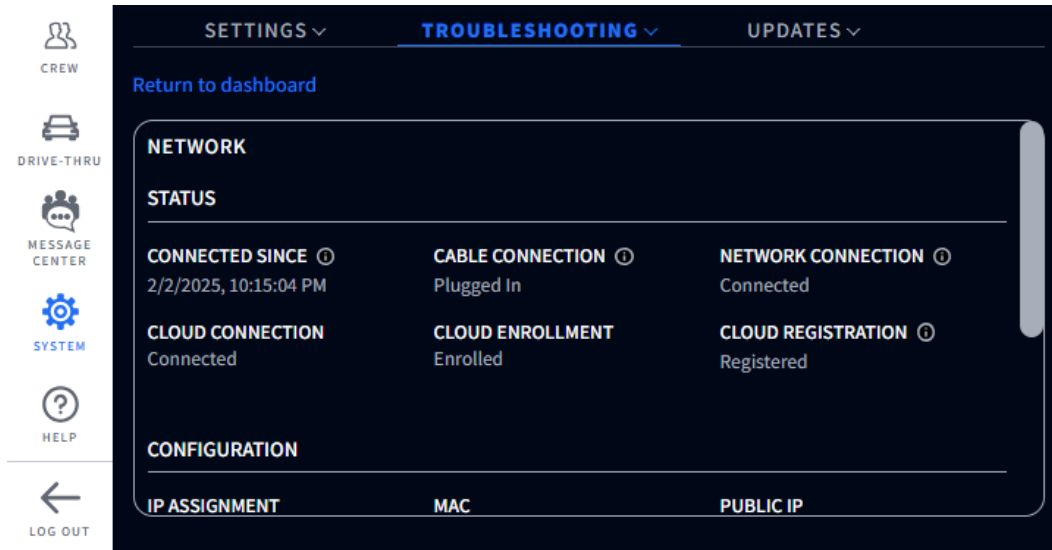

Fig. 14.4

Figure 14.5 is an example of what you see when the Network Connectivity Test is in progress.

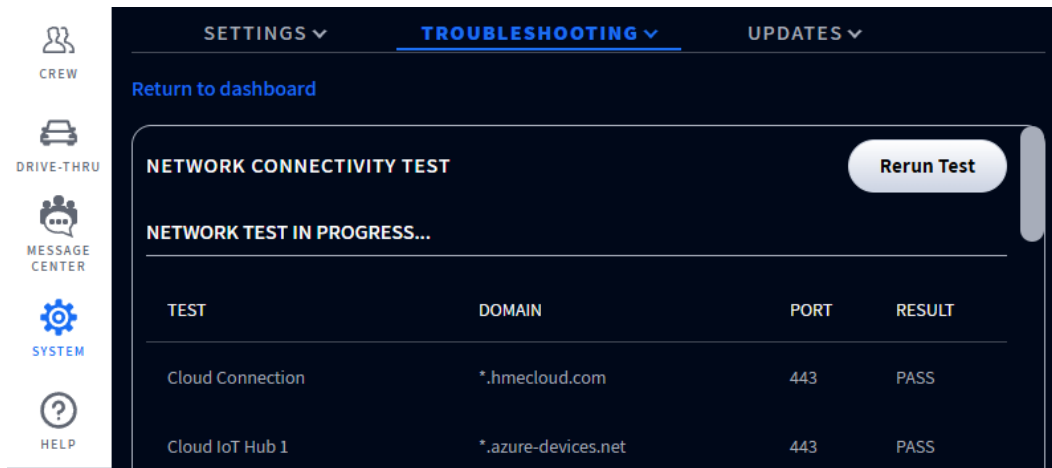

Fig. 14.5

Figure 14.6 is an example of what see when you click on the Audio option. Scroll down further to view Lane 2.

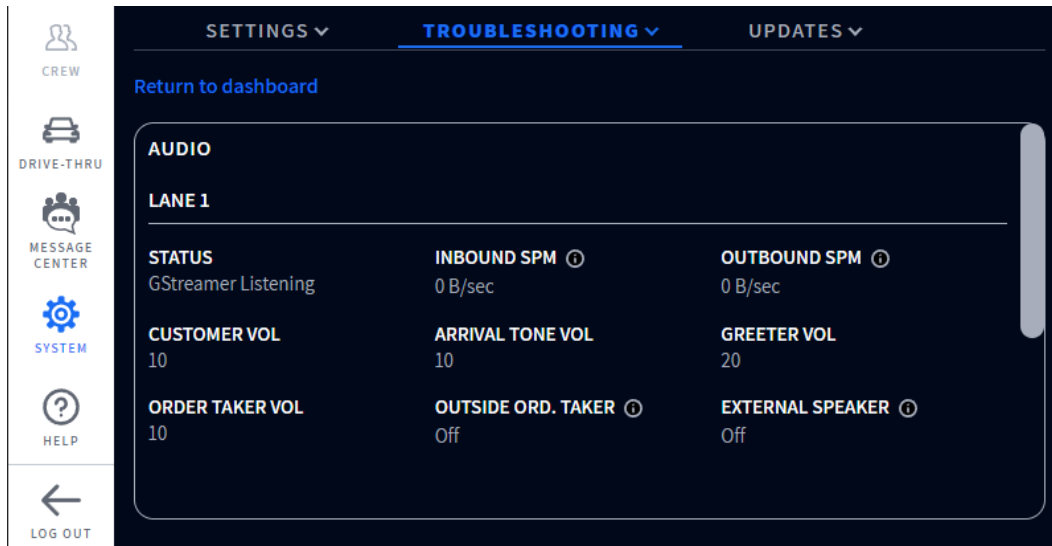

Fig. 14.6

Figure 14.7 is an example of what see when you click on the Speaker/Mic Posts option.

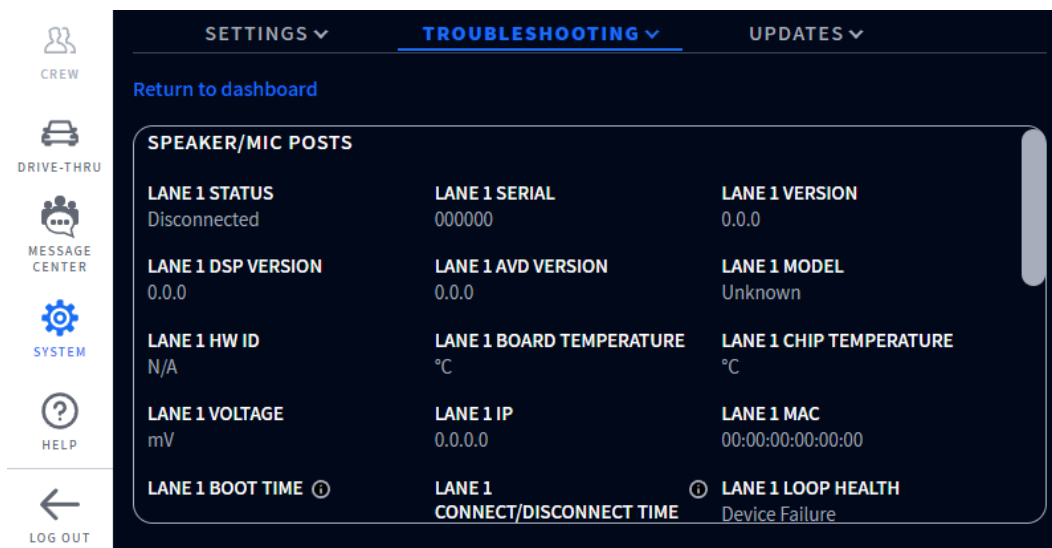

Fig. 14.7

Figure 14.8 is an example of what you see when you click on the VAIO option. VAIO is only available for customers with a NEXEO | Pro subscription. Also see "AOT (Automated order taking)" on page 28.

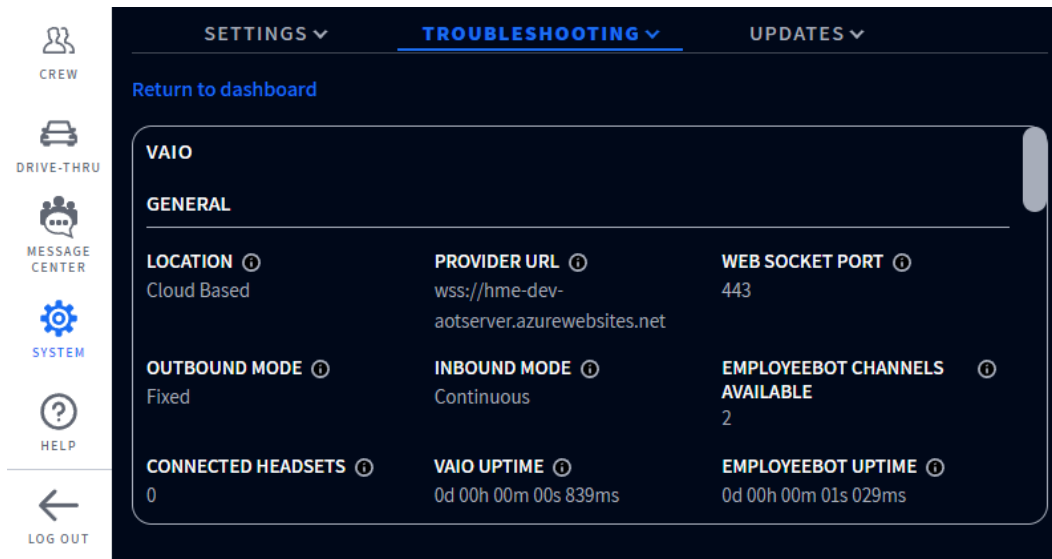

Fig. 14.8

ADDITIONAL TROUBLESHOOTING

If your system malfunctions, a red indicator on the HOME screen will alert you to where the problem is (see color-code definitions below). Then, try resetting the system component in question via the Base Station. For example, if the problem is the Speaker/Mic Posts:

1. Select SYSTEM from the sidebar menu.
2. Log in to the system.
3. Select the TROUBLESHOOTING tab.
4. Choose Speaker/Mic Posts from the drop-down list.
5. Tap on the Restart Speaker/Mic Post button and follow the prompt to reset.

Or, try resetting the system:

1. Select SYSTEM from the sidebar menu.
2. Log in to the system.
3. Select the TROUBLESHOOTING tab.
4. Choose Base Station from the drop-down list.
5. Tap on the Restart Base Station button and follow the prompt to reset.

Electrical Power Outage: If your system fails to function properly after an electrical power outage, power the system off and unplug the AC power adapters from their electrical outlets. Wait a few seconds, then plug them back in and power the system back on.

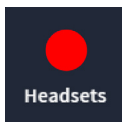

A red indicator like this one doesn't always indicate a failure. It may indicate that the feature/component is offline, inactive or possibly something else requiring corrective action. In this example there are no headsets detected, a headset needs to be turned on and paired for this marker to turn green. Tapping on the indicator will also reveal more details.



A red indicator like this one indicates a critical system failure, and requires immediate attention. In this example the Transceiver has failed, which might be caused by a disconnected or failed Ethernet cable or a loss of power. The system cannot function in this condition until the failure is resolved.

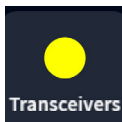

A yellow indicator indicates an intermediate or transitional state such as scanning or an alert. When the Base Station is turned on, reset, or receives an upgrade, the transceiver indicator initially turns yellow as it scans the area for available channels before turning green. This can take a few minutes.

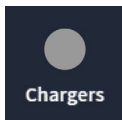

A gray indicator like this one indicates that no AC70 Smart Battery Charger is sensed. Plug in the AC70 and position it within 10 feet (3 m) of the Base Station for it to turn green. Note: this marker is not red because the AC70 can function independently and does not require a Base Station connection to be functional.

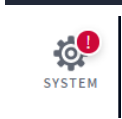

A red exclamation mark like this indicates a new firmware update is available.

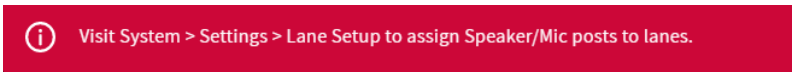

A red banner like this is a prompt requiring attention. This banner contains the path to the item requiring attention. In this example you are asked to go to Settings tab of the SYSTEM screen. "Lane Settings" is found in the Settings drop-down list. Once there you will notice that the Speaker Selection field prompts you to "Select One." For a single-lane, there is only one entry to choose from, so select this entry. The Save button appears, click Save and the speaker/Mic post is now assigned to the lane. The red banner on the Home page disappears.

FIRMWARE UPDATES

Red Exclamation Marks like the one next to the SYSTEM icon in Fig. 14.7 indicates that a feature or component requires attention such as a firmware update.

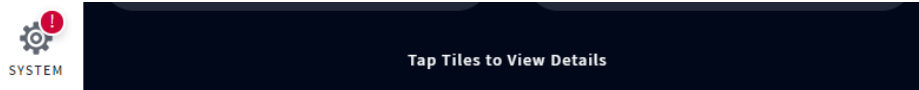

Fig. 14.7

1. Log in using your four-digit PIN and proceed to the SYSTEM screen. The Red Exclamation Mark is now also visible next to the UPDATES tab.
2. Tap on the UPDATES tab. In this example, the Base Station option requires attention. See Fig. 14.8.

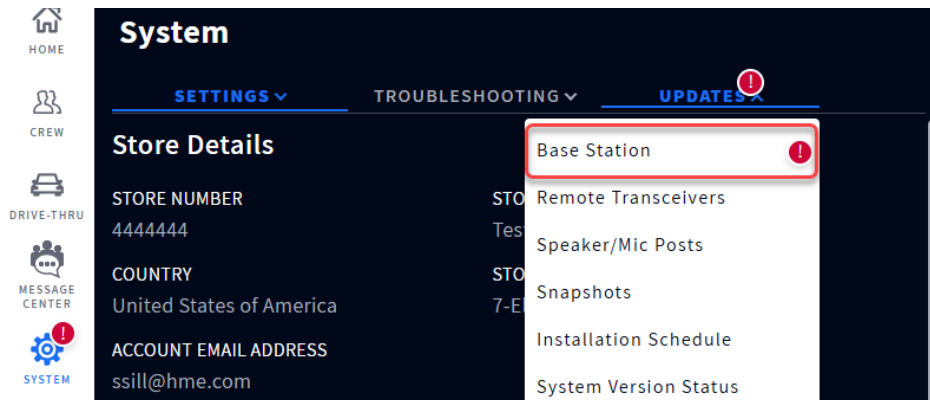

Fig. 14.8

3. Select Base Station from the drop-down list (Fig. 14.8).
4. Tap the Update button that appears on the right (Fig. 14.9).

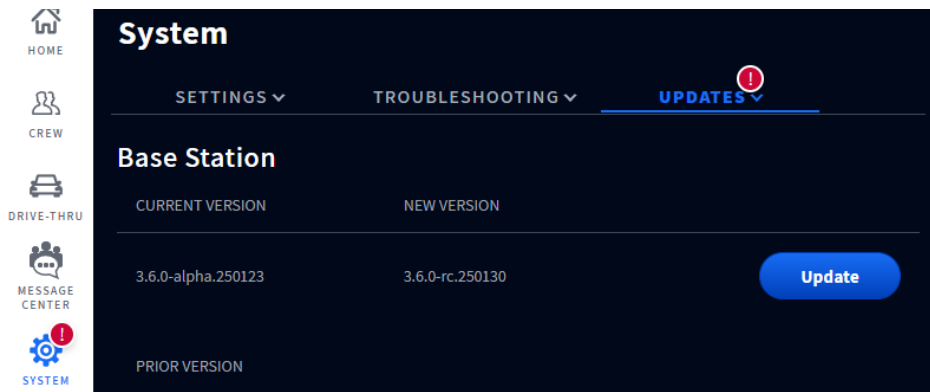
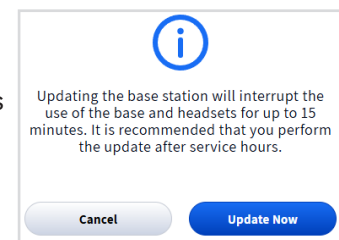

Fig. 14.9

5. A prompt appears informing you that the update will interrupt the use of the base station and headset and takes up to 15 minutes to update. Tap/click the Update Now button to continue. The update begins and provides a progress status. The red exclamation mark also disappears when the update is initiated.



GLOSSARY OF TERMS

Attenuation: Attenuation is a telecommunications term that refers to a reduction in signal strength commonly occurring while transmitting analog or digital signals over long distances. Attenuation is historically measured in dB, but it can also be measured in terms of voltage.

Base Station: This is the central control unit for your system. The Base Station interfaces with all system components, including the Cloud. System features are configured and controlled here; headsets are also paired here.

ClearSound: This is a patented digital processing technology used to remove background noise from audio transmissions.

CSV: Comma-Separated Value, is a file containing values separated by a delimiter, and formatted as a database table.

DHCP: Dynamic Host Configuration Protocol is a network management protocol used on UDP/IP networks. A DHCP server dynamically assigns an IP address and other configuration parameters to each device on a network so they can communicate with other IP networks.

Dropout: This is the term used when a vehicle is present at a detection point but not detected by the system.

DNS Server: Domain Name Server is a directory of domain names with translated IP addresses.

Gateway: A device (usually a router) that connects one or more computers on a network to other networks.

Ghost Car/Vehicle: This is the term used when there are detection anomalies that occur when a vehicle is detected at one detection point but not detected at another. There are a few reasons why this can occur; for example, a vehicle drives over a detection point and then leaves the lane before reaching the next detection point or vice versa. Another example is if vehicles are too close together but are detected as one vehicle. Or, if a vehicle moves too quickly across one of several detection points to be detected.

Headset: This is the device worn by your crew/staff and used for 2-way communication between employees and customers. It consists of an earpiece with keypad and a boom microphone. The system uses two headset models:

- **AIO (All-In-One):** This headset is used by the drive-thru crew and can communicate with customers at the drive-thru menu and speaker post.

HME CLOUD: This is a remote server used by your system. It allows your system to access and store data via the internet. It also provides access to other systems in your network connected to the HME CLOUD.

IP Address: Internet Protocol Address. A unique computer address that some electronic devices (such as computers or routers) use to identify and communicate with each other on a network.

NTP: Network Time Protocol is a networking protocol for clock synchronization between computer systems and is intended to synchronize all participating systems to within a few milliseconds of local standard time or Coordinated Universal Time (UTC)

Pairing: This is an initiation process required to establish a wireless connection between two or more devices allowing them to find, recognize and communicate with each other. It pairs a device to the system's control unit; headsets for example must be paired with the Base Station before they can be used. They need to be paired every time they are put back into service if they have been logged out of the system when not in use.

Registration: This is a one-time function that registers a new device with an existing system. Headsets when used for the first time are registered at the base station. This happens automatically with the initial pairing. Once registered, the headset becomes a part of the system even though they still need to be paired with each use.

Registration Key: This is unique identifying key generated when a new store is initiated by the sales department. It allows HME products to be linked to a specific store ensuring easier installations with reduced errors while also enhancing subscription management.

Radio/Remote Transceiver: Sometimes referred to as RFP (Radio Fixed Part) is the combined radio/antenna system that facilitates wireless communication between headsets and the base station. At least one is required per store but up to four can be installed as range extenders for larger premises. A radio transceiver can accommodate ten chat channels and ten private communication channels.

Run-on: This is the term used for a vehicle that has departed from a detection point but is still sensed as being present.

Speaker: These are speakers in addition to the headset speakers, providing another source of audio for inside or outside the store. Speakers are installed externally at menu boards to communicate with customers and can also be installed inside the store enabling a manager to address employees such as those without headsets.

Subnet Mask: Splits the network into a series of subgroups or subnets to speed up the delivery of data by the routers.

System Version: This is a version suite, a collective of all device firmwares under a single system version.

Tooltip: This is a pop-up tip box dialog that provides information or help for a feature, term, link, button or icon. Hovering over or tapping on an element that has a tooltip associated with it, triggers the tooltip to appear. The tooltip caret points to or is centered on the element that triggered it.

Web Server Port: This is the unique network port number used by NEXEO to communicate over the network it is connected to.

AOT GLOSSARY OF TERMS

ASR: This refers to the process of automatic speech recognition, often used to transform speech to text (STT) for further analysis and interpretation.

BOT Escalation: When the BOT is not able to understand the intention of the QSR customer or the language spoken by them is not supported, it sends an escalation request, to indicate the crew members that assistance is needed.

Crew-Takeover: When a crew member taps 1 or 2 on their headset keypad, a crew takeover signal is sent to the BOT to indicate that the order will be taken by the restaurant crew member.

MQTT: This is a lightweight transport (over TCP/IP) protocol that uses the publish/subscribe messaging pattern, ideal for Internet of Things (IoT) solutions.

RTSP: The Real Time Streaming Protocol is a network control protocol designed for use in entertainment and communications systems to control streaming media servers.

Streaming Server: This is a component that runs inside the NEXEO base as a service, and it mainly listens to connections from clients on a specific port (RTSP Port), has the capability to send and receive audio streams, and provides the ability to control the media transmissions via commands.

TTS: This refers to the process of transforming text to speech (TTS), used to produce audio from a text script.

SPECIFICATIONS

BS7000	
Dimensions	7.62" H x 12.579" W x 3.669" D (193.55 x 319.51 x 93.19 mm)
Weight	3.5 lb (1.59 kg)
Power Supply	Input Voltage: 100 - 240 VAC nominal Output Voltage: 48 VDC Current: 1.88 A Power: 90 W
LAN	Gbit Ethernet
Front Panel	LCD type: 800x480 TFT w/ capacitive touch
Rear Panel	RJ45 (x5), USB type C, USB type A, PCBA mounted power supply & component headers
Temperature	Operating Temperature range: 0°C (+32°F) to +50°C (+122°F).
Compliance	See NEXEO HDX - Regulatory, Compliance, and Safety Guide online

HS7000 All in One (AIO) Headset	
Dimensions	5.2" H x 5.2" W x 2.1" D (132.1 x 132.1 x 53.3 mm) with boom excluded 9.2" H x 5.2" W x 2.1" D (234.4 x 132.1 x 53.3 mm) with boom extended down
Weight	3.67 oz (104.04 g) with battery included
Power Supply	Voltage: 3.7 VDC, powered from a rechargeable Lithium-ion battery
Frequency Range	Audio: 100 Hz to 7.48 kHz
Wireless	Main Radio: 5.180 GHz – 5.8525 GHz Secondary Radio: 2.402 GHz - 2.480 GHz
Power, Watts	Nominal Power with listening only: 0.314 W Maximum Power with dedicated mode: 0.407 W
Keypad type	Touch Sense
Temperature	Operating Temperature range: 0°C (32°F) to +50°C (+122°F) Storage Temperature range: -10°C (14°F) to +80°C (+176°F)
Compliance	See NEXEO HDX - Regulatory, Compliance, and Safety Guide online

AC70	
Dimensions	5.09" L x 3.64" W x 1.84" H (129.2 x 92.4 x 46.7 mm)
Weight	5.97 oz (169.19 g)
Power Supply	Input Voltage: 100 - 240 VAC nominal Output Voltage: 5 V; 4 A. Charge Output: ~ 3 W per port MTBF (min.): 300,000 hours demonstrated
Wireless	Wireless PAN, 2.4 GHz Wireless Technology
Front Panel	Four charging ports for BAT70 LED type: 4 x RGB, for port/battery charging status
Side Panel	Four storage ports for BAT70 (Storage ports do not charge)
Temperature	Operating Temperature range: 32°F - +104°F (0°C - +40°C) Storage: -40°F to +176°F (-40°C to +80°C) Humidity: 0 - 95%, non-condensing
Compliance	See NEXEO HDX - Regulatory, Compliance, and Safety Guide online

RT7000

Dimensions	6.705" H x 7.157" W x 1.56" D (170.31 x 181.79 x 39.62 mm)
Weight	13.95 oz (395.6 g)
Power Supply	Voltage: 48 VDC (powered from BS7000). Current: 60 mA pk-pk @ 48 V
LAN	Ethernet wired connection to Base Station - AES/EBU interface
Frequency Range	Main Radio: 5.180 GHz – 5.8525 GHz Secondary Radio: 2.402 GHz - 2.480 GHz
Power	2.88 W
Front Panel	LED type: 5 x RGB, one for power and 4 for port indication
Rear Panel	RJ45 port
Temperature	Operating Temperature range: -25°C (-13°F) to +60°C (+140°F).
Compliance	See NEXEO HDX - Regulatory, Compliance, and Safety Guide online

IB7000

Dimensions (IB only)	5.68" H x 5.68" W x 2.05" D (144.3 x 144.3 x 52.1 mm)
Dimensions (Cover only)	6.79" H x 5.85" W x 2.22" D (172.3 x 148.6 x 56.4 mm)
Dimensions: IB with Cover	6.79" H x 5.85" W x 2.83" D (172.3 x 148.6 x 71.6 mm)
Weight: IB with Cover	19.2 oz (543 g). IB = 14.4 oz (408.2 g), cover = 4.8 oz (135 g)
Power Supply	Voltage: 48 VDC (powered from BS7000) Current: 0.331 A (max start up)
Frequency Range	Audio: 100 Hz to 7.4 kHz Powerline network over 48 VDC: 2 MHz – 67.5 MHz
Power	Nominal power with no audio: 5.2 W Maximum power at maximum volume: 22 W
Front Panel	Two adhesive strips for mounting to a vertical surface
Rear Panel	Phoenix connector type headers (includes speaker output and analog DM5 microphone input)
Wireless	N/A
Temperature	Operating Temperature range: -25°C (-13°F) to +60°C (+140°F)
Compliance	See NEXEO HDX - Regulatory, Compliance, and Safety Guide online

SS7000

Dimensions	3.92" H x 5.76" W x 3.44" D (99.6 x 146.3 x 87.4 mm)
Weight	1.14 lb (492.6g)
Power Supply	Voltage: 48 VDC, powered from BS7000
Frequency Range	Audio: 100 Hz to 7.4 kHz
Power	15 watts, 8 ohm
Rear Panel	Phoenix connector type headers
Wireless	N/A
Temperature	Operating Temperature range: -25°C (-13°F) to +60°C (+140°F)
Compliance	See NEXEO HDX - Regulatory, Compliance, and Safety Guide online

SP10	Speaker
Dimensions	5.62" H x 5.62" W x 4.5" D (142.8 x 142.8 x 114.3 mm)
Dimensions with foam gasket	5.62" H x 5.62" W x 4.75" D (142.8 x 142.8 x 120.6 mm)
Weight	2.55 lb (1.16 kg)
Power	15 W
Impedance	8 Ω
Temperature	Operating Temperature range: -22°F to +140°F (-30°C to +60°C)

DM5	Microphone
Dimensions	2.81" H x 2.81" W x 1.78" D (71.5 x 71.5 x 45.1 mm)
Weight	4.37 oz (123.9 g)
Microphone Type	Electronic
Impedance	200 Ω
Temperature	Operating Temperature range: -22°F to +140°F (-30°C to +60°C)

Optional Accessory (only available for the US and Canadian market)

TI7000	Telephone Interface
Dimensions	6.6" L x 4.5" W x 1.8" H (168 x 113 x 46 mm)
Weight	7.8 oz (221 g)
Power Supply	Voltage: 12 VDC, powered from BS7000
Panel	RJ11 and RJ45 connector type ports and two on/off switches
Wireless	N/A
Temperature	Operating Temperature range: -25°C (-13°F) and +45°C (+113°F)
Compliance	See NEXEO HDX - Regulatory, Compliance, and Safety Guide online



A copy of this guide and much more including Regulatory, Compliance,
and Safety information can be found by scanning this QR code or going to:
<https://www.hme.com/qsr/drive-thru-user-manuals/>

© 2025 HM Electronics, Inc.
*The HME logo and product names are registered trademarks of HM Electronics, Inc.
All rights reserved.*